

Segmental Retaining Walls Best Practices Guide

for the Specification, Design, Construction,
and Inspection of SRW Systems

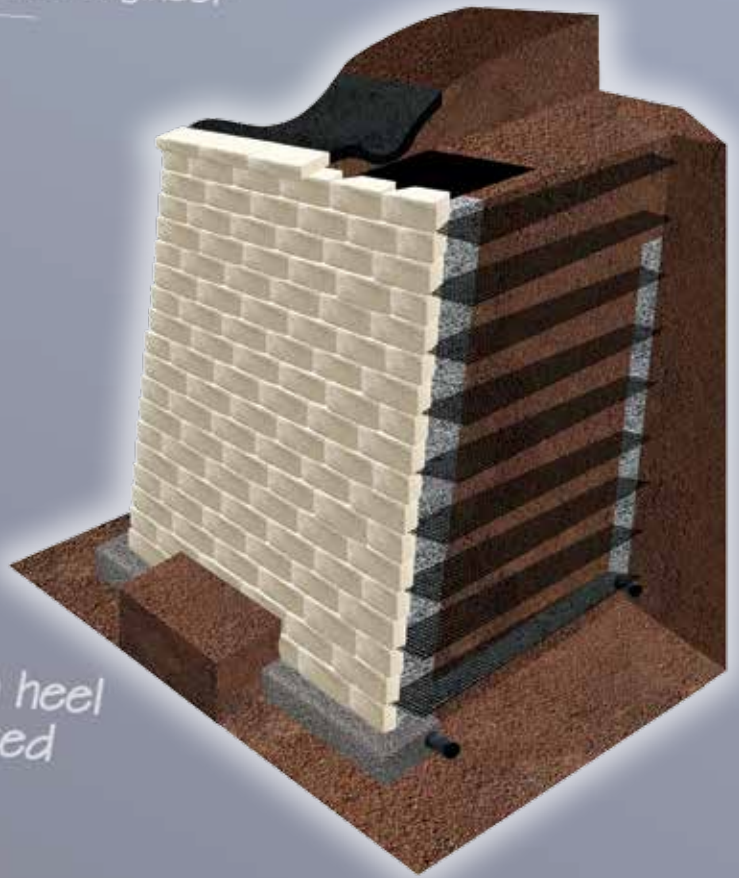
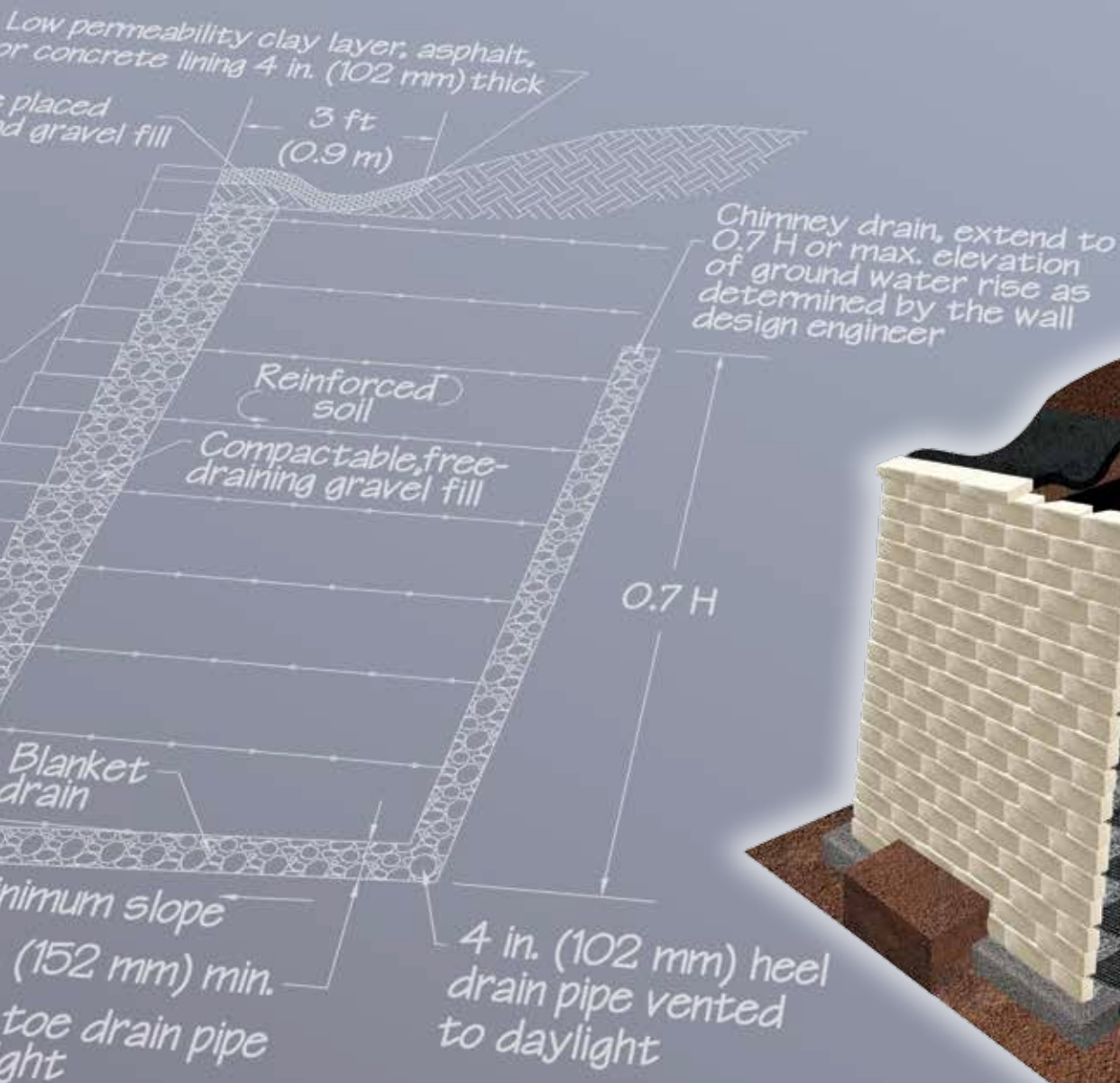

About NCMA	3
Acknowledgments	3
Preface	4
Chapter 1 – Preconstruction Considerations	5
1.1 Design Roles and Responsibilities.....	6
1.1.1 Site Civil Engineer Responsibilities	6
1.1.2 SRW Design Engineer Responsibilities	6
1.2 Planning Considerations.....	7
1.2.1 Project Objectives	7
1.2.2 Site Planning and Layout	8
1.2.3 Geotechnical Report.....	8
1.2.4 SRW Construction Drawing Submittals.....	8
1.2.5 Project Bidding.....	9
1.2.6 Preconstruction Meetings	9
1.3 General Design Considerations	9
1.3.1 Wall Embedment Depth	11
Chapter 2 – SRW Units and Geosynthetic Materials	13
2.1 SRW Units.....	13
2.1.1 Minimum Property Requirements for SRW Units.....	13
2.1.2 Freeze/Thaw Durability Requirements	14
2.1.3 Sulfate Resistance	16
2.2 Geosynthetic Reinforcement.....	16
2.3 Geotextile Material (Filter Fabric).....	17
Chapter 3 – Soils and Compaction	19
3.1 On-Site Soils.....	20
3.2 Foundation Soils	20
3.3 Reinforced Soils.....	20
3.4 Retained Soils	21
3.5 Gravel Fill	21
3.6 Compaction Requirements at the Wall Face	22
3.7 Soil Parameter Verification	22
3.8 Inspection and Testing Recommendations	22
Chapter 4 – Water Management; General Design Considerations 23	
4.1 Water Management.....	24
4.1.1 Surface Water	24
4.1.2 Below Grade Water.....	25
Chapter 5 – Construction Considerations	31
5.1 Contractor Experience.....	31
5.2 Leveling Pad.....	31
5.3 Drain Pipe.....	31
5.4 SRW Unit Placement.....	32
5.5 Compaction Requirements.....	32
5.6 Water Management during Construction.....	32
5.7 Capping and Finish Grading.....	32
5.8 Wall Step-Ups in Base Course.....	32
5.9 Stair Considerations.....	33
5.10 Construction Tolerances.....	33
5.11 Construction Safety	33

Chapter 6 – Geosynthetic Reinforcement Installation	35
6.1 General	36
6.1.1 Proper Orientation of Geogrid and Placement.....	36
Chapter 7 – Inspection and Quality Assurance	37
7.1 Overview.....	37
7.2 Soil Inspection and Testing	37
7.3 SRW Units.....	37
7.4 Geosynthetic Reinforcement.....	37
Chapter 8 – Tall Walls	39
8.1 Tall Walls.....	40
8.1.1 Select Granular Backfill.....	40
8.1.2 Compaction Requirements.....	40
8.1.3 Gravel Fill at the Face.....	40
8.1.4 Quality Control, Quality Assurance.....	40
8.2 SRW Unit Height Tolerances	41
8.3 Cracking	41
Chapter 9 – Global Stability	43
9.1 General	44
9.1.1 Wall Embedment with Toe Slope.....	44
9.1.2 When to Analyze Global Stability.....	44
9.1.3 Increase Global Stability Options.....	44
Chapter 10 – Terraced Walls	45
10.1 Tiered or Terraced Walls	46
Chapter 11 – Water Applications	47
11.1 Water Applications.....	48
Chapter 12 – Seismic Considerations	49
12.1 Seismic Considerations.....	50
Chapter 13 – Above Wall Considerations	51
13.1 Above the Wall Considerations	52
13.1.1 Minimum Geogrid Lengths at the Top of the Wall	52
13.1.2 Fences and Railings	52
13.1.3 Traffic Barriers and Guide Rails	52
13.1.4 Slopes Above the Wall.....	52
13.1.5 Landscaping	52
Chapter 14 – Corners and Radii	53
14.1 General	54
Chapter 15 – Checklists	57
15.1 Preconstruction Checklist	57
15.2 Design Checklist	57
15.3 Construction and Inspection Checklist.....	57
15.4 Post Construction Checklist	59
Chapter 16 – Notations	61
Chapter 17 – References	63

Segmental Retaining Walls Best Practices Guide for the Specification, Design, Construction, and Inspection of SRW Systems

About NCMA

The National Concrete Masonry Association (NCMA) is an international trade association representing producers and suppliers in the concrete masonry and hardscape industry. The Association is dedicated to the advancement of manufactured concrete products through research, promotion, education, and the development of manufacturing guides, design codes and resources, testing standards, and construction practices.

NCMA promotes the use of segmental retaining wall products through the development and dissemination of technical information. This Guide was prepared by NCMA and is intended for use by those involved in the specification, design, construction, inspection, and maintenance of SRW systems. The material presented herein has been reviewed by numerous individuals from a variety of backgrounds to ensure the enclosed

information is accurate and conforms to current engineering practices. NCMA assumes no responsibility for errors or omissions resulting from the use of this Guide.

All illustrations and other graphic representation published in this manual are property of NCMA unless otherwise noted.

Acknowledgments

The efforts undertaken by Allan Block Corporation in the initial drafting of this publication are greatly appreciated as is the support and commitment of NCMA's SRW Technical Subcommittee.

Additional reviewers and contributors to this Guide include: Don Armstrong, Anchor Wall Systems/Oldcastle; Tim Bott, Allan Block Corporation; Glenn Herold, Oaks Concrete; Rich Lovdal,

Allan Block Corporation; Karen Nelson, Versa-Lok Corporation; David Pitre, Pavestone Systems; Robert Race, Race Engineering; Scott Vollmer, Oldcastle.

© 2017 National Concrete Masonry Association | 13750 Sunrise Valley Drive | Herndon, VA 20171 | www.ncma.org

NCMA Publication Number: TR308

Edition: 1

Printing: 2 - Last Revised September 6, 2017

This Guide, *Segmental Retaining Walls Best Practices Guide for the Specification, Design, Construction, and Inspection of SRW Systems*, is published and maintained by the National Concrete Masonry Association (NCMA). Since segmental retaining wall systems were first introduced in the 1980s, there has been a continuous evolution and advancement in the understanding of the technology and performance of these systems related to material properties, design recommendations, and construction practices. This Guide reflects a compendium of contemporary knowledge collected over several decades that highlight practical, field-proven solutions using segmental retaining walls (SRWs). The information and recommendations presented in this Guide are intended to augment the design practices and recommendations contained within NCMA's *Design Manual for Segmental Retaining Walls* (Ref. 1), but are equally applicable regardless of the design methodology selected.

The creation of this resource was driven by the establishment of NCMA's Zero Failures Initiative; an industry-wide program to educate owners, designers, site civil engineers, geotechnical engineers, and installers of SRW systems on the industry's recommended practices and to promote a philosophy that strives for ensuring successful wall performance. As a Guide, this document is not meant to override engineering judgment or common sense, as different projects often have unique conditions or combinations of conditions that may warrant special consideration. As with any project, the project specification and related construction documents must define the minimum acceptable material properties and construction requirements to ensure targeted performance objectives are met. The retaining wall designer must use the best engineering judgment to account for project-specific situations and

provide an efficient and safe design for the wall owner.

Segmental retaining wall projects cover the spectrum of applications; from simple, do-it-yourself projects to highly complex endeavors involving multiple, interdependent design and construction considerations. The scope of this Guide applies to those projects where an SRW design engineer is needed to assess site conditions, interpret the recommendations of this Guide, and apply engineering judgment as necessary for a successful project. The context of the discussion and recommendations presented in this Guide is limited solely to reinforced SRW applications. Refer to NCMA's *Design Manual for Segmental Retaining Walls* (Ref. 1), TEK 18-11B, *Inspection Guide for Segmental Retaining Walls* (Ref. 14), and related industry resources for additional guidance, information and recommendations for both conventional (gravity) and reinforced SRW applications. The scope of this guide does not apply to DIY residential applications and projects of similar, smaller scope where an engineer is not involved.

Ideally the engineer of record for the retaining wall should be the project site civil engineer as they are best suited to take responsibility for the design and how it affects the site; whether they do the design in-house or use an outside consultant to do the SRW design for the project. The project site civil engineer has control of several of the overall aspects of the project and therefore is most able to properly handle the integration and communication required to ensure the performance of the wall complies with the needs of the site and the objectives of the owner. Alternatively, for wall design applications that are outside of the experience level of the project site civil engineer, an SRW design engineer

with the appropriate knowledge and experience should be contracted by the project site civil engineer. It is recommended that the wall contractor not be responsible for securing the design services.

When properly executed, SRW structures offer long-lasting solutions to a wide array of applications. Successful projects, require:

- The use of quality materials suitable for the anticipated exposure conditions;
- A thorough understanding of SRW design methodology and the potential impacts site variables (soil conditions, site geometry, water management, loading sources and scenarios, etc.) can have on the performance of SRW systems;
- Clear communication between all parties (owner, designer, contractor, etc.) before, during, and after construction; including a thorough understanding of performance objectives, roles and responsibilities; and
- Adherence to construction documents, drawings, and details; including conformance to applicable standards and industry recommendations.

This document provides users with the industry's recommended best practices covering each of these topics that are drawn from decades of research, field observations, and expertise to ensure SRW systems perform as intended.

NOTE:

The scope of this guide does not apply to DIY residential applications and projects of similar, smaller scope where an engineer is not involved.

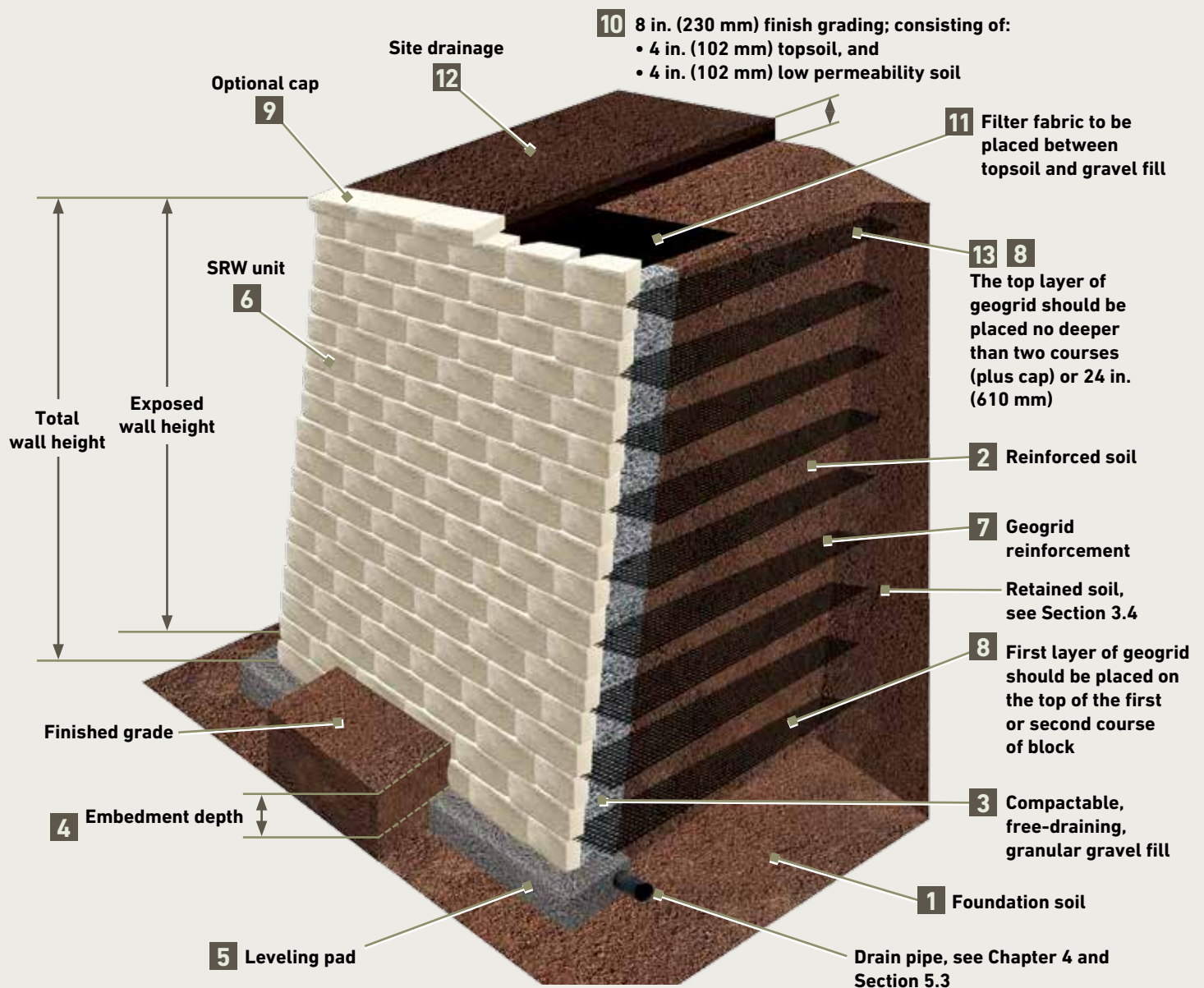

Figure 1 | General Criteria

- 1 Foundation soil** – see Section 3.2.
- 2 Reinforced soil** – soil placed within the zone of reinforcement (Section 3.3). For tall walls, see Section 8.1.1.
- 3 Gravel fill** – minimum of 12 in. (305 mm) gravel fill placed behind block with not less than 24 in (610 mm) combined unit/gravel fill thickness (Section 3.5). For tall walls, see Section 8.1.3.
- 4 Embedment depth** – determined by the SRW design engineer in conjunction with the site civil engineer (Section 1.3.1). For water applications, see Section 4.1.2 and Chapter 11.
- 5 Leveling pad** – densely compacted gravel or unreinforced, low strength concrete (Section 5.2).
- 6 SRW unit** – wall unit properties appropriate for application (Section 2.1).
- 7 Geogrid** – type, spacing and length varies with design with minimum lengths equal to 60% of total wall height or 4 ft (1.2 m). Geogrid length is measured from wall face (Section 2.2 and Chapter 6).
- 8** Refer to Chapter 6 for additional considerations for locating and laying out the geogrid.
- 9 Capping** – wall caps should be secured in place using a high quality manufacturer recommended adhesive. See Section 5.7.
- 10 Finish grade** – see Section 5.7 for finish grading options.
- 11 Filter fabric** – see Section 2.3 and Chapter 4 for additional recommendations for selecting and detailing filter fabric.
- 12 Site drainage** – see Section 4.1.1 for methods to manage surface water at top of wall.
- 13** See Chapter 13 for additional above-wall considerations.

Chapter Summary

Key preconstruction topics covered in this chapter include:

- Recommendations regarding the roles and responsibilities for the owner, site civil engineer, SRW design engineer, and SRW installer.
- Preplanning considerations including owner's objectives, project schedule, code requirements and design method to be used, wall layout and site conditions impacting wall location, and targeted quality assurance and inspection tasks.
- Information to be included in the geotechnical report, construction drawings, and submittals.
- Guidance for project bidding, preconstruction meetings, staging, and considerations that may impact the layout and detailing of the wall.

1.1 DESIGN ROLES AND RESPONSIBILITIES

Prior to the initiation of a project, the owner should work with the SRW design engineer to establish the scope of responsibilities and understand the limits of the SRW design engineer's responsibilities. Segmental retaining walls are a relatively new earth retention system in North America, which has led to the frequent use of design-build relationships where the SRW design engineer works for the SRW installer. **This practice should be avoided to minimize potential conflicts of interest while ensuring that the SRW design engineer works for, and is accountable to, the project owner.** The recommended roles and responsibilities for the different parties involved in the construction of SRW systems are discussed in detail in NCMA TEK 15-3A, *Roles and Responsibilities on Segmental Retaining Walls Projects*, (Ref. 3) and Chapter 3 of *Design Manual for Segmental Retaining Walls* (Ref. 1), which are summarized here.

1.1.1 Site Civil Engineer Responsibilities

The site civil engineer is typically responsible for providing the following services:

- If within the contracted services, act as the SRW design engineer.
- Verify that global stability has been considered by either the geotechnical engineer or other.
- Identify and specify retaining walls appropriate for the project conditions.
- Prepare site and grading plans, including slopes above and below the SRW, SRW heights, and wall alignments.
- Address any space limitations and easement issues relevant to the layout of the SRW and verify the wall and reinforced soil zone can be constructed within site boundaries and easements.
- Design surface grading for drainage and design for erosion control around the SRW. Consider both construction and post-construction drainage and erosion control.
- Design storm water collection structure(s) and detention/retention pond(s).
- Utility design and layout around the SRW installation.
- Pavement section design and grading above the SRW.
- Layout of traffic control structures, such as pedestrian fall protection, curbs, wheel stops, guide rails, and traffic barriers behind the SRW installation.
- Hydrologic evaluations, including water flows, scour depths, flood areas, and high water level predictions around the SRW.
- Ensure SRW design engineer is contracted for involvement in preconstruction meetings.
- Coordination of construction inspection services.
- If not covered within the SRW design engineer's contracted services, review SRW material submittals and observe construction of the SRW installation.

In addition to design services, the owner should separately contract for and fund:

- The geotechnical investigation and report including global stability analysis.
- Site inspection, field testing, and related quality assurance activities.

Where possible, the SRW design engineer of record should be, or work for, the site civil engineer as the site engineer is best suited to take responsibility for the design and how it affects the overall site; regardless of whether they do the design in-house or use an external consultant. The project site civil engineer has control of several of the overall aspects of the project and therefore is most able to properly handle the integration and communication required to ensure the performance of the wall meets the needs of the site. For wall design applications that are outside of the experience level of the project site civil engineer, a designer with the appropriate knowledge and experience in SRW systems should be subcontracted by the project site civil engineer. Once approved, the plans and specifications provided by the SRW design engineer cannot be modified without engaging all impacted parties.

1.1.2 SRW Design Engineer Responsibilities

Key aspects of the SRW design engineer's services include:

- Design of SRWs for structural stability including external stability (sliding and overturning), internal stability, facial stability, and internal compound stability.
- Design the geosynthetic reinforcement layout and strength.
- Determine the minimum embedment depth of the wall. (The wall embedment may be controlled by other design variables such as global stability or erosion control, which are typically determined by the site civil engineer. The SRW design engineer and site civil

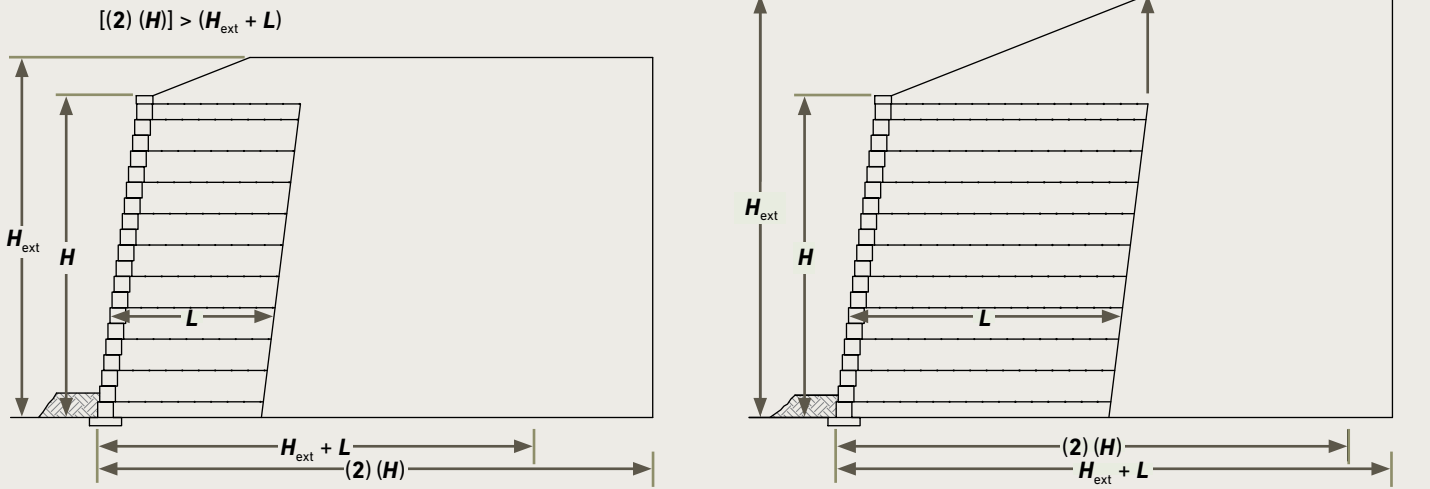

Figure 1.2-1 | SRW Design Envelope Limits

engineer should coordinate as necessary when establishing wall embedment.)

Unless other arrangements have been made between the owner and the SRW design engineer, the SRW design engineer should account for all design variables within the design envelope as illustrated in Figure 1.2-1. The design envelope extends a horizontal distance measured from the toe of the wall taken equal to the larger of the following:

- Twice the height of the wall (2H); or
- The height of the projection from the tail of the reinforcement to the finished grade above the wall (H_{ext}) plus a distance equal to the length of the reinforcement (L).

It is recommended that the SRW design engineer work for, and be paid directly by, the project owner, owner's representative, or site civil engineer and that the wall contractor not be responsible for securing the engineering services or perform the quality assurance activities. Field experience has repeatedly shown that maintaining a direct owner-designer contractual relationship ensures the critical decision-making path is in the best interest of the owner.

1.2 PLANNING CONSIDERATIONS

Based on the design concepts presented in NCMA's *Design Manual for Segmental Retaining Walls* (Ref. 1), research, and field experience, the following best practices are recommended prior to the start of construction.

1.2.1 Project Objectives

At the onset of a project, the site civil engineer and SRW design engineer should meet with the owner (or the owner's representative) to understand the specific needs for the project, including:

- How the site will be used; such as whether the project is part of a commercial, residential, or infrastructure improvement venture and whether the owner or owner's representative is a public or private entity.
 - Site use can often dictate design loading, design methodology, and level of effort required for project completion, which may impact the bidding process.
- Establishing the design methodology to be used. Currently recognized design methodologies in North America include: NCMA (Ref. 1), AASHTO (Ref. 4), FHWA

(Ref. 5). Where project conditions or design variables are outside of the scope or provisions of these design references, design should be augmented with engineering judgment as required for the specific project application(s).

- Defining the timeline for the project. Project scheduling, interruption of services, seasonal variations, and other variables can impact a project's timeline. Identifying these critical issues early can mitigate future problems.
- Understanding any special conditions unique to the project or required by the owner.
 - Local codes or ordinances may stipulate minimum requirements for the design and construction of segmental retaining walls. Similarly, site conditions such as existing structures or utilities, steep slopes, lot line proximity, or poor soil conditions may warrant additional considerations.
 - Special assessment(s) by the owner may include installer credentialing, performance bond, minimum warranty, or rigorous inspection criteria during construction.

- Whether as-built documents will be required, and if so, establishing procedures to document changes during construction.
- Define aesthetic objectives including color, texture, pattern, wall transitions, corners, and radii.

1.2.2 Site Planning and Layout

Where practical, the site civil engineer (and if possible the SRW design engineer) should visit the site prior to design initiation to ensure that the site plans adequately capture the important details of the site, including:

- Existing site drainage and topography, surface water, soil characteristics, property lines, and existing or proposed locations of structures, roads, and utilities.
 - Avoid placing utilities, especially storm sewer, sanitary sewer, water, landscape irrigation, and gas lines, within the reinforced zone when running parallel (both horizontally and vertically) to the face of the wall. If no other alternatives exist, provisions should be established for future maintenance of these utilities.
 - Site topography, particularly slope conditions above and below the proposed wall location, will impact design.
- Site access constraints that may impact construction or staging. Projects with multiple phases or limited access may require the consideration of additional loading conditions during construction as a result of temporary roadways or material storage.
- If site conditions vary from the site plan, the owner or owner's representative must be notified to provide a solution and/or authorize alternatives.
- The project plans should include quality assurance and inspection provisions, including periodic site visits. Site visits should be

documented in writing and typically occur:

- At the beginning of the project to reinforce the need for the contractor to comply with the specifications in the approved design and to answer any questions, or following site work to verify foundation and retained soils and presence of potential ground water issues.
- At a random time following the start of construction to ensure that the work methods are in agreement with the approved plans and to answer any questions.
- At the conclusion of the project to verify that the construction has been properly executed and the details above and below the wall structure have been completed as required. Additional site visits can be added at the request of the owner.

Upon verification of the site plans, a preliminary retaining wall layout should be established considering the following:

- Wall heights and any special conditions at the top or bottom of the wall.
- Loading criteria including location and magnitude as well as special loading conditions from surcharges or earthquakes.
- Site conditions or project requirements that may trigger a global stability analysis.
- Site drainage and the potential need to route water away from the retaining wall.
- Acceptance of the SRW location and layout by the owner or owner's representative.

1.2.3 Geotechnical Report

The owner or the site civil engineer should separately contract with a geotechnical engineer to obtain a comprehensive geotechnical report for the area where the segmental retaining wall will be located. The minimum information to be provided within the report includes:

- Description and characterization of on-site soils: gradation, plasticity index, liquid limit, soil strength (including tested friction angle), bearing capacity, settlement potential, and unit weight.
- Groundwater conditions.
- Site-specific seismic coefficients (if applicable).
- Global stability recommendations.
- Recommendations to remediate or resolve poor quality foundation soils through soil replacement, piles, piers, etc. (if applicable).
- Soil test borings along the proposed wall alignment; both along the wall face and at the rear of the reinforcement.
- Settlement estimates for the foundation soils and proposed fill soils.

If no other guidelines are stipulated, the soil borings for the geotechnical report should be spaced at a maximum of 100 feet (30 m) intervals along the alignment of the proposed wall location and at 150 feet (46 m) along the back of the reinforced soil zone. When bedrock is encountered, the geotechnical engineer should verify its suitability for the intended application.

1.2.4 SRW Construction Drawing Submittals

At a minimum, a typical construction drawing submittal should include the following information:

- Wall plan view showing wall orientation on original site plan.

- Wall profile view showing:
 - The location of geosynthetic reinforcement, elevation of top and bottom of the wall, and finished grade at the bottom and top of the wall.
 - Wall station data with corresponding elevation for exposed grade at top and bottom of wall (i.e. profile data).
 - Wall section markers depicting locations of design sections.
- Design sections showing:
 - SRW unit type;
 - Leveling pad elevation and dimensions;
 - Any required drain locations;
 - Project specific cross sections;
 - Geosynthetic reinforcement type, locations, and length;
 - Gravel fill thickness and reinforced fill depth;
 - Any surcharges;
 - Sufficient wall sections to allow the contractor to properly construct the wall; and
 - When required, dimension(s) and location(s) of any formwork or other features to be installed behind the wall during wall construction. See Section 13.1 for more details.
- Any required specialized or standard details that will provide guidance to the contractor.
- Design criteria and assumptions covered in Section 1.3 of this Guide.
- Material (units, reinforcement, and soil) properties in accordance with Section 2 and 3 of this Guide.
- General and specific construction requirements in accordance with Section 4, 5, and 6 of this Guide.
- Any inspection and quality assurance requirements covered in Section 7 of this Guide.
- Where applicable, additional considerations recommended within Sections 8 through 14 of this Guide should be considered.

1.2.5 Project Bidding

The owner should provide a complete design for all walls, unless the project is a negotiated design-build contract on the front end. If design-build (not contractor supplied design) is used, the owner should ensure that a complete design is submitted and construction verification is validated by an engineering firm working directly for the owner. Otherwise, the complete bid package should include at a minimum:

- A complete geotechnical report per Section 1.2.3.
- A complete set of construction drawings and documents per Section 1.2.4.
- Minimum requirements for the contractor, including minimum credentials and installation experience. At a minimum, NCMA recommends SRW installers are trained and certified by a nationally recognized SRW installer certification program, such as NCMA's SRW Installer Certification, or equivalent.
- Minimum services the contractor must provide. This typically includes materials and construction services, testing necessary to verify the compaction, finish grading, and landscaping.
- Any other information or details about the site and final requirements that is pertinent to the completion of the project.

1.2.6 Preconstruction Meetings

Understanding and communicating project objectives early is critical to the successful completion of any SRW project. A preconstruction meeting should be done to engage all the parties (owner, contractor, design engineer, landscape architect, geotechnical engineer, and site civil engineer) involved with the project to approve the design, construction practices, field verification and inspection, site access, timeline and scheduling, and other relevant aspects of the project. Preconstruction meetings are usually

organized by the owner or owner's representative to:

- Review the entire construction plan from start to finish and resolve any identified issues prior to the start of construction.
- Engage all impacted parties that will be working on or around the wall site, including but not limited to: the owner, architect, site civil engineer, geotechnical engineer, SRW design engineer, general contractor, excavation contractor, SRW installer, SRW supplier representative, railing or fence installer, local utility representative, and inspectors.
- Meeting topics include, but are not limited to: contractor qualifications, schedule and phasing of wall construction, coordination with other on-site construction activities, responsibilities of parties, and sources, quantity, quality, and acceptance of materials (geogrid SRW units, soils, etc.). Chapter 15 of this Guide includes recommended topics to cover during a preconstruction meeting.

1.3 GENERAL DESIGN CONSIDERATIONS

Before initiating the design, the design engineer and owner should agree on the design methodology to be used as several options exist, including: NCMA (Ref. 1), AASHTO (Ref. 4), and FHWA (Ref. 5). Where project conditions or design variables are outside of the scope or provisions of these design references, the design should be augmented with engineering judgment as required for the specific project application(s). Retaining wall design should follow the defined methodology and meet or exceed the minimum targeted design safety factors (or Capacity Demand Ratio, CDR, for LRFD design methodology). NCMA's ASD-based minimum safety factors, adapted from *Design Manual for Segmental Retaining Walls* (Ref. 1), are shown in Table 1.3-1.

Design loads will vary both in type and magnitude for different SRW projects. It is also possible for temporary loads,

Table 1.3-1 | Minimum SRW Design Requirements

Minimum Safety Factor	Static	Dynamic (Seismic)*
Sliding (Base/Internal)	1.5	75% of Static
Overturning	2.0	75% of Static
Geogrid Overstress	1.5	75% of Static
Pullout from Soil/Block	1.5	75% of Static
Internal Compound Stability	1.3	1.1
Global Stability	1.3	1.1
Bearing Capacity	2.0	75% of Static
Additional Detailing Criteria		
Minimum Reinforced Zone Width	60% of Wall Height (H)	60% of Wall Height (H) for Bottom and Middle Layers; 90% of Wall Height (H) for Upper Layers
Minimum Wall Embedment	6 inches (152 mm)	6 inches (152 mm)
Minimum Anchorage Length	12 inches (305 mm)	12 inches (305 mm)
Maximum Wall Batter	20 degrees	20 degrees
Maximum Geogrid Spacing	See Table 1.3-2	16 inches (406 mm)

* See section 12.1 for conditions where seismic design should be considered

such as those seen during construction or resulting from a heavy snowfall, to govern the final design. Additional loading considerations include:

- Material storage during construction.
- Temporary roadways for site access.
- Lateral loading resulting from plows pushing snow into the face of the wall or surcharge loading resulting from snow piled on top of the wall.
- Potential planned use(s) of the area above the wall while in service.
- Additional design loads required by building codes or regulatory requirements.

All standard design methodologies use a coherent gravity mass design theory for stability calculations. A coherent gravity mass is made up of the wall facing and layers of geogrid reinforcement placed horizontally through properly

compacted soils. The length, strength and spacing between layers of geogrid are critical to ensuring the internal stability of the mass; as does the depth of the facing unit which helps to stabilize the overall composite structure while concurrently providing erosion control at the face.

The past several decades have seen an array of varying recommendations regarding both maximum geogrid spacing as well as minimum geogrid length to ensure satisfactory performance. The recommendations contained within this guide, including those for geogrid spacing and length, are predicated on the use of a facing unit that has an average depth of at least 10 in. (254 mm). (In practice the terms 'unit width' and 'unit depth' are often used interchangeably. Both refer to the dimension of the unit perpendicular to the face of the wall. In the context of this guide, 'unit depth' is used.) The 10 in. (254 mm) limitation is recommended

because SRW units of this depth or greater have a proven performance record while in service over many decades. This recommendation also recognizes that as the unit depth decreases, so does the stability of the facing, particularly overturning resistance during construction or while in service.

Depending upon the design methodology used, the default minimum geogrid length ranges from 60% (Ref. 1) to 70% (Ref. 4) of the wall height (measured from the face of the wall); but oftentimes will be longer to satisfy other design considerations such as global stability. Likewise, choosing an appropriate geogrid spacing ensures the creation of a stable, reinforced soil mass that easily and uniformly distributes internal pressures.

The appropriate geogrid spacing for a given project will be determined through proper engineering analysis

Table 1.3-2 | General SRW Design Criteria Recommendations

Wall Height, ft (m)	Reinforced Zone Material			Design and Layout Criteria		
		Gradation	Plasticity	Reinforcement Spacing, Max.	L/H, Min.	Gravel Fill Thickness, in. (mm)
H ≤ 10 (H ≤ 3)	Recommended	Table 3.3.1	Pl < 20, LL < 40	24 in. (610 mm)	0.6	24 in. (610 mm) from face 12 in. (305 mm) behind unit
	Alternate	Table 3.3.1; No. 200 waived	Pl < 20, LL < 40	16 in. (406 mm)	0.7	30 in. (762 mm) from face 18 in. (457 mm) behind unit
10 < H ≤ 20 (3 < H ≤ 6)	Recommended	Table 3.3.1	Pl < 6,	24 in. (610 mm)	0.6	Top 10 ft (3 m) same as above, remainder 36 in. (914 mm) from the face, 24 in. (610) behind unit
H > 20 (H > 6)	Recommended	Table 8.1.1-1	Pl < 6	24 in. (610 mm)	0.6	Top 10 ft (3 m) and lower 10 ft (3 m) to 20 ft (6 m) same as above, remainder 48 in. (1219 mm) from the face, 36 in. (914 mm) behind unit

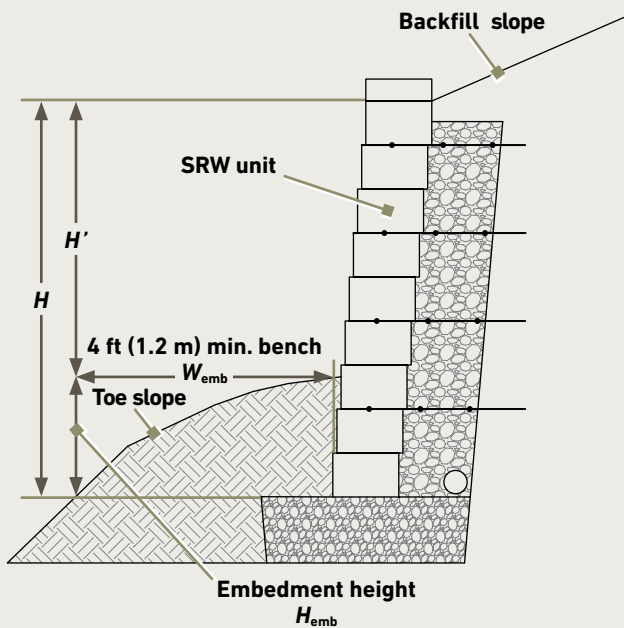

Slope in front of wall	Minimum H_{emb} to top of leveling pad
Horizontal (walls)	$H'/20$
Horizontal (abutments)	$H'/10$
3H:1V	$H'/10$
2H:1V	$H'/7$
Minimum embedment	6 in. (152 mm)

NOTE: H' is the exposed height of the SRW. The bottom of the wall should not be above the finished grade elevation 4 ft (1.2 m) in front of the wall.

Figure 1.3-1 | Minimum Wall Embedment Depth, H_{emb}

augmented by engineering judgment. The geogrid spacing should not exceed 24 in. (610 mm), but could be less depending upon project-specific design and construction variables. Design factors that influence geogrid spacing include: quality of backfill, internal and external stability, height of wall, above-wall slopes or surcharges, existing or proposed structures in close proximity to the wall, and design methodology.

Additional guidance for the layout and design of SRWs is provided in Table 1.3-2.

1.3.1 Wall Embedment Depth

Embedment depth should follow the recommendations in Figure 1.3-1. When toe slopes, high surcharges, or erosion at the toe of the wall are present, the minimum embedment

depth may need to be increased. A minimum soil cover should be provided in front of the retaining wall as summarized in Figure 1.3-1 for different front slopes and project conditions, but never less than that required for global stability, erosion control, or greater as may be required by local requirements.

2.1 SRW UNITS

Manufactured using dry-cast concrete, SRW units provide the finished surface for the SRW system; enhancing the project's aesthetics while providing function through strength, stability, and erosion control. SRW units are readily available in a myriad of sizes, colors, surface textures, weights, and wall batter to meet the challenges of virtually any project. While readily available, care should be given to understanding and specifying the appropriate SRW unit properties to match the expected exposure conditions, application needs, and owner expectations. In harsh environments, special unit properties may be warranted – and while readily available, may not be 'off-the-shelf' requiring additional lead time when purchasing.

The minimum requirements for SRW units are covered in ASTM C1372, *Standard Specification for Dry-Cast Segmental Retaining Wall Units* (Ref. 6). As with any product standard, these minimum requirements are appropriate for many, but not all, applications where SRW systems are used. The best practices and recommendations of this Guide offer suggestions where additional considerations to the minimum requirements of ASTM C1372 may be warranted. Topics and issues to consider when specifying SRW units include:

- Understand the owner's expectations. More stringent requirements for SRW units can

be specified, but often at a price premium. Pricing should be compared to alternative systems of comparable quality, not just baseline systems that may not have the same performance objectives for a given application.

- SRW units having specialized properties may be a special order or custom run and therefore may not be immediately available; adding to lead times. As always, contact local suppliers for options and unit availability to meet specific needs.
- Consider what the 'standard of care' is for the region where the SRW project is located. For example, freeze/thaw durability is not a concern in Florida, but is in Minnesota. Taking this into consideration will aid not only in the selection of appropriate SRW unit properties, but will make unit procurement easier as local SRW suppliers will be familiar with the performance expectations and unit properties for their local markets.
- Don't relax the SRW unit properties to make it easier/less expensive to find materials. Doing so could lead to long-term performance or durability concerns.
- Where custom properties are desired, they should be clearly and prominently called out in the plans and bid specifications.
- Many SRW producers have an

established quality control program in place. Such producers can not only provide units of consistently high quality, but can also aid in selecting the appropriate SRW unit properties for the intended application.

2.1.1 Minimum Property Requirements for SRW Units

The minimum physical properties for segmental retaining wall units are defined by ASTM C1372 and summarized in Table 2.1.1-1.

The recommendations contained within this guide, including those for geogrid spacing and length, are predicated on the use of a facing unit that has an average depth of at least 10 in. (254 mm). (In practice the terms 'unit width' and 'unit depth' are often used interchangeably. Both refer to the dimension of the unit perpendicular to the face of the wall. In the context of this guide, 'unit depth' is used.) Deeper units are inherently more stable than shallower units, particularly overturning resistance during construction or while in service. This recommendation recognizes that as the unit depth decreases, so does the stability of the facing, particularly overturning resistance during construction or while in service. The 10 in. (254 mm) limitation is also recommended because SRW units of this depth or greater have a proven performance record while in service over many decades.

Table 2.1.1-1 | ASTM C1372 Minimum Requirements for SRW Units

Average Minimum Compressive Strength, psi (MPa)			3,000 (20.1)
Permissible Variation from Specified Dimensions			+/- 1/8 in. (3.2 mm)
Unit Density	Lightweight SRW: Density Less than 105 lb/ft ³ (1,680 kg/m ³)	Medium Weight SRW: Density of 105 lb/ft ³ (1,680 kg/m ³) to 125 lb/ft ³ (2,000 kg/m ³)	Normal Weight SRW: Density Greater than 125 lb/ft ³ (2,000 kg/m ³)
Average Maximum Absorption, lb/ft ³ (kg/m ³)	18 lb/ft ³ (288 kg/m ³)	15 lb/ft ³ (240 kg/m ³)	13 lb/ft ³ (208 kg/m ³)

Unlike conventionally mortared masonry construction, SRW systems are dry-stacked, which not only eases construction, but allows the wall to move in response to external loads without cracking. Further, because there is no mortar joint, SRW units are typically manufactured having specified dimensions equal to nominal dimensions to maintain modular coursing over the height of the wall. Dry-stacking can, however, present unique challenges during construction that are not seen with conventionally mortared masonry. Whereas minor imperfections on the top or bottom surfaces of a masonry unit that is laid in mortar are not a concern because the mortar can be used to adjust and accommodate such imperfections, dry-stacking relies on the planeness and levelness of the top and bottom bearing surfaces of the SRW unit. In order to facilitate construction and maintain an SRW assembly's plumb and level over its height, ASTM C1372 requires that the height tolerance of SRW units be no more than $\pm 1/8$ inch (3.2 mm) from the specified height. This dimensional tolerance is waived by ASTM C1372 for the depth of SRW units that are split, simply recognizing that the splitting process is intended to provide a rough, non-uniform texture to the finished wall surface and therefore by intent cannot achieve a $\pm 1/8$ inch (± 3 mm) dimensional tolerance. Additionally, because two of the three dimensions on an SRW unit are typically controlled by molded surfaces when manufactured, these dimensions rarely deviate significantly provided that the manufacturer regularly inspects and maintains their molds.

Beginning in 2013, the ASTM requirements for measuring and verifying the height tolerances of SRW units were revised to require that the height of each unit being evaluated be measured at six locations across the unit cross-section rather than the previously required two locations. This change in the testing procedures captures much more accurately the height profile of an individual unit by

identifying potential high or low spots on the SRW unit – while maintaining the same $\pm 1/8$ inch (± 3 mm) height tolerance. In effect, while the permitted height tolerance for SRW units has not changed, the method of measurement has, resulting in units of more consistent heights under contemporary standards compared to what was allowed historically. Nevertheless, ASTM C1372 recognizes that not every SRW unit will be 'perfect' and allows up to 5% of a lot to exceed the maximum dimensional tolerances.

2.1.2 Freeze/Thaw Durability Requirements

The minimum compressive strength and maximum absorption values defined by ASTM C1372 help to ensure a minimum level of durability and performance for a wide range of exposures and applications. In areas where repeated freezing and thawing under saturated conditions occur, ASTM C1372 requires that freeze/thaw durability be demonstrated by test or by proven field performance. When testing is required, the units are tested in water in accordance ASTM C1262, *Standard Test Method for Evaluating the Freeze-Thaw Durability of Dry-Cast Segmental Retaining Wall Units and Related Concrete Units* (Ref. 7). Compliance testing in accordance with ASTM C1372 demonstrates one of the following:

- the individual weight loss of five test specimens at the conclusion of 100 cycles in water does not exceed 1% of the initial weight; or
- the individual weight loss of four of the five test specimens at the conclusion of 150 cycles in water does not exceed 1.5% of the initial weight.

ASTM C1372 does not stipulate freeze/thaw testing in a saline solution. Like all concrete products, dry-cast concrete SRW units are susceptible to freeze-thaw degradation with frequent exposure to moisture coupled with de-icing salts and cold temperature. In applications where the units will

be repeatedly exposed to de-icing salts consideration should be given to specifying SRW units that have demonstrated satisfactory performance when evaluated for freeze/thaw durability in a saline solution. Using the same testing procedures defined in ASTM C1262, SRW units can be tested for freeze/thaw durability in a 3% sodium chloride saline solution.

If saline testing is conducted, freeze/thaw testing in water is typically not necessary as it is generally recognized and accepted that testing in saline is a much more rigorous evaluation. Additional design and detailing considerations include:

- Avoid using SRW products for steps or walkways where de-icing salts will be used.
- Where runoff containing de-icing salts may frequently flow over or onto the wall, provide a collection basin and either pipe the water around the wall or provide an extended shoot where the saline water does not flow down the surface of the wall.
- Where de-icing chemicals frequently land on a segmental retaining wall, consider specifying a more durable capping unit.
- In areas where SRWs will be repeatedly exposed to snow (such as from snow plowing operations), consider periodically applying sealants or water repelling chemicals (silane or siloxane compounds) to the wall surface.

As additional guidance for the selection of unit properties based on exposure conditions, NCMA has identified and defined three different climate and exposure zones. In addition to the above freeze/thaw evaluation recommendations, the recommendations of Table 2.1.2-1 should be considered for varying exposure and environmental conditions that are applicable to roadway applications and similar projects based on engineering judgment.

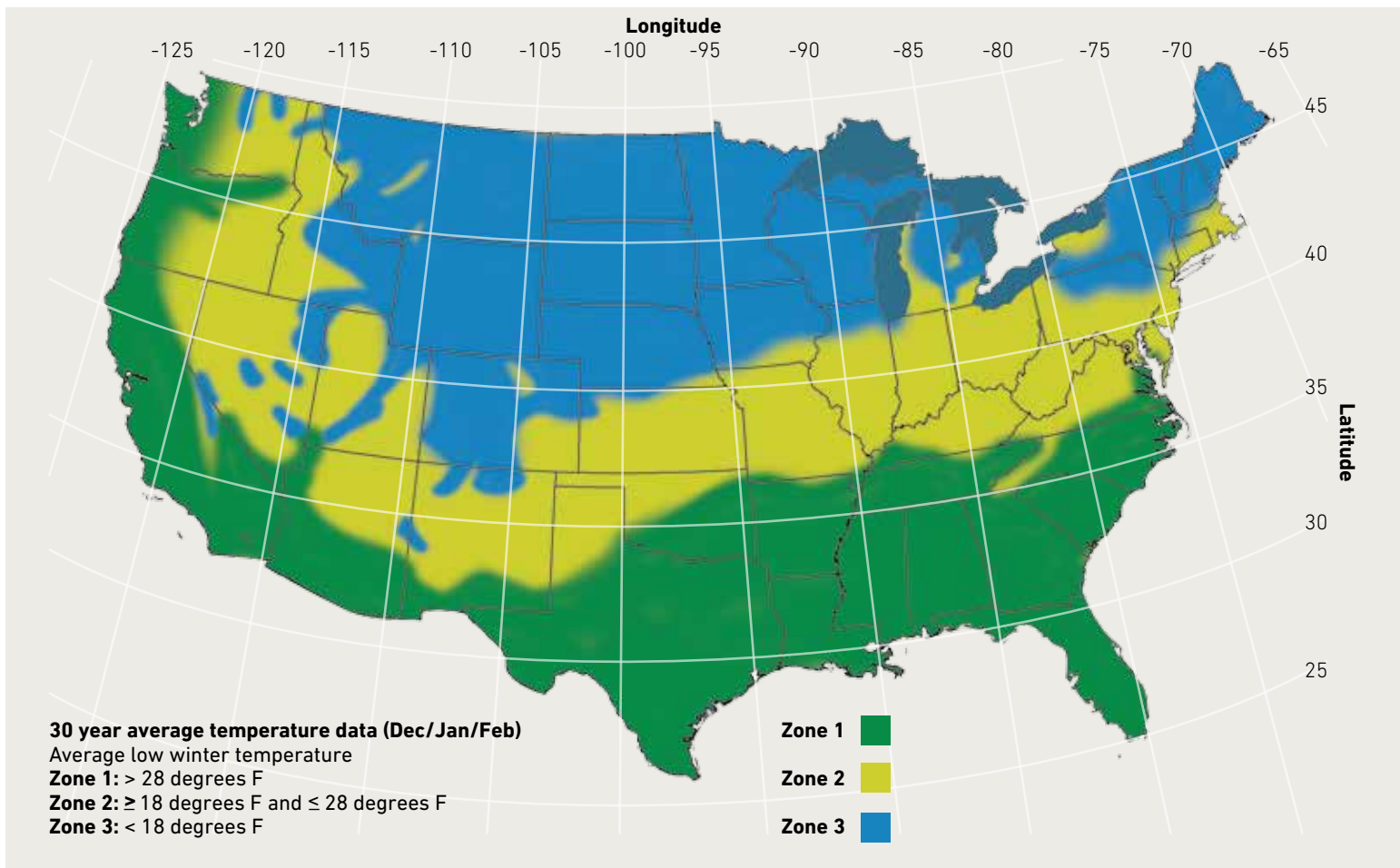

Figure 2.1.2-1 | Climate Exposure Zones for Roadway Applications per Table 2.1.2-1

- **Zone 1 (Negligible)** – If the 30-year average monthly low temperature averaged over the months of December, January, and February is above 28 degrees F (-2 degrees C), the project location is defined as Zone 1.
- **Zone 2 (Moderate)** – If the 30-year average monthly low temperature averaged over the months of December, January, and February is greater than or equal to 18 degrees F (-8 degrees C), but less than or equal to 28 degrees F (-2 degrees C), the project location is defined as Zone 2.
- **Zone 3 (Severe)** – If the average monthly low temperature averaged over the months of December, January, and February is less than 18 degrees F (-8 degrees C), the project location is defined as

Zone 3.

The exposure zones are graphically illustrated in Figure 2.1.2-1. Alternatively, if the exposure zone for a specific location cannot be reasonably determined from Figure 2.1.2-1 and for areas not shown in Figure 2.1.2-1, it can be determined by averaging the average low temperature for the months of December, January, and February for that location using publicly available data.

The expected use of de-icing salts is project-specific. Where SRW units are expected to be exposed to de-icing salts on a regular basis, freeze/thaw testing should be conducted using a 3% saline solution considering the above recommendations. Where de-icing salt exposure is not expected, either due to project needs or a relatively low occurrence of precipitation, freeze/thaw

testing should be conducted in water where necessary. Refer to Table 2.1.2-1 for additional guidance on freeze/thaw testing of SRW units and performance objectives.

Because freeze/thaw testing of units can take months to perform, it is impractical to sample units from a job site for freeze/thaw testing because the project may be completed before the freeze/thaw testing. Rather than sampling units at the job site, the following recommendations should be considered for verifying the durability of SRW units delivered to a project:

- Prior to the start of construction, the SRW producer should provide a current freeze/thaw test report for the product proposed to be used. (When required, ASTM C1372 stipulates that freeze/thaw testing be conducted every

Table 2.1.2-1 | Freeze/Thaw Durability Recommendations for Roadway and Non-Roadway Applications

Exposure Zone	SRW Properties ³	Freeze/Thaw Testing
Zone 1 and Non-Roadway Applications	ASTM C1372	None
Zone 2 – no/negligible de-icing salt exposure ¹	ASTM C1372	Proven field performance or test in water per ASTM C1262: <ul style="list-style-type: none"> • ≤1% weight loss in 5 of 5 samples after 100 cycles; or • ≤1.5% weight loss in 4 of 5 samples after 150 cycles.
Zone 2 – de-icing salt exposure ²	ASTM C1372, plus <ul style="list-style-type: none"> • Targeted compressive strength: 4000 psi (27.6 MPa) • Targeted absorption: 7 lb/ft³ (112 kg/m³) 	Test in 3% saline solution per ASTM C1262: <ul style="list-style-type: none"> • ≤1% weight loss in 5 of 5 samples after 20 cycles; or • ≤1.5% weight loss in 4 of 5 samples after 30 cycles.
Zone 3 – no/negligible de-icing salt exposure ¹	ASTM C1372, plus <ul style="list-style-type: none"> • Targeted compressive strength: 4000 psi (27.6 MPa) • Targeted absorption: 7 lb/ft³ (112 kg/m³) 	Test in water per ASTM C1262: <ul style="list-style-type: none"> • ≤1% weight loss in 5 of 5 samples after 100 cycles; or • ≤1.5% weight loss in 4 of 5 samples after 150 cycles.
Zone 3 – de-icing salt exposure ²	ASTM C1372, plus <ul style="list-style-type: none"> • Targeted compressive strength: 5500 psi (37.9 MPa) • Targeted absorption: 7 lb/ft³ (112 kg/m³) 	Test in 3% saline per ASTM C1262: <ul style="list-style-type: none"> • ≤1% weight loss in 5 of 5 samples after 40 cycles; or • ≤1.5% weight loss in 4 of 5 samples after 50 cycles.

¹Exposure to de-icing salts is unlikely or unplanned, but may include occasional exposure.

²Exposure to de-icing salts is likely or expected.

³The minimum compressive strength and maximum absorption values listed for each climate zone are general targets rather than absolute values. Unit durability assessment is quantified through ASTM C1262 testing. Therefore, units that have higher or lower compressive strength or absorption values than shown here are acceptable provided that the units perform adequately in freeze/thaw testing.

24 months provided that no changes to the mix design, constituent materials, manufacturing process, and curing method have been implemented.) This test report should document the freeze/thaw testing observations (either in water or saline, as appropriate for the project) as well as the average compressive strength, average unit density, and maximum water absorption.

- Units selected for a project should be tested for compressive strength, density, and absorption. The tested compressive strength and density should equal or exceed the values

reported at the project initiation and the absorption should be less than or equal to the absorption previously reported. If these conditions are met, the durability of the units delivered to the project would be expected to be equivalent to or better than the units previously evaluated for durability through ASTM C1262 testing.

- If the compressive strength is more than 5% less than that previously reported, the density is more than 2% less than that previously reported, or the absorption is more than 5% greater (relative) than that previously reported, then additional units should be sampled and tested

for freeze/thaw durability (either in water or saline, as appropriate) and verified for compliance with the project specifications. For example, if the benchmark absorption is 6.2 lb/ft³ (99 kg/m³) and the subsequently verified absorption is 6.4 lb/ft³ (99 kg/m³), then the relative difference in the measured absorption would be $(6.4-6.2)/6.2 = 3.2\%$; and would thereby satisfy this condition.

2.1.3 Sulfate Resistance

In areas where the SRW assembly will be exposed to high concentrations of sulfates either in the soil or water features adjacent to the SRW assembly,

Table 2.1.3-1 | Recommendations for SRW Units Exposed to Sulfate-Containing Soils and Solutions

Sulfate Exposure	Sulfate (SO ₄) in soil, % by mass	Sulfate (SO ₄) in water, ppm	Cement Type		
			ASTM C150	ASTM C595	ASTM C1157
Negligible	Less than 10%	Less than 150	No special type required		
Moderate (sea water)	0.10 to 0.20	150 to 1500	II	IP (MS) IS(<70)(MS)	MS
Severe	0.20 to 2.00	1500 to 10,000	V	IP (HS) IS(<70)(HS)	HS
Very Severe	Over 2,000	Over 10,000	V	IP (HS) IS(<70)(HS)	HS

the recommendations of Table 2.1.3-1 should be considered.

2.2 GEOSYNTHETIC REINFORCEMENT

Use a geosynthetic reinforcement that has obtained a National Transportation Product Evaluation Program (NTPEP) for Geosynthetic Reinforcement (REGEO) evaluation. The NTPEP REGEO program provides an independent, third party, evaluation and on-site audit of geosynthetic reinforcement. These reports include design reduction factors for creep and installation damage, which may or may not be applicable for all projects, but should be reviewed by the SRW design engineer for applicability. Current NTPEP reports are available online in the Datamine section of the NTPEP website, www.ntpep.org.

There are many different international manufacturers that are supplying geosynthetic reinforcement of varying quality and consistency. While the strength of the geogrid is an important design consideration, durability of the reinforcement can be equally important to the long-term performance of the system. Understanding what influences the durability of the geosynthetic reinforcement is critical when specifying or approving a geogrid. The following three key geogrid durability

factors have been identified by the U.S. Federal Highway Administration:

- **Soil pH** – Soils that have a pH of 10 or more represent an environment that could potentially degrade the geosynthetic reinforcement faster, especially in the presence of sufficient water.
- **Polyester Molecular Weight** – The size of the polymer molecule has a significant influence on the chemical durability.
- **Polyester Carboxyl End Group (CEG)** – Geogrids are less susceptible to degradation when they have fewer CEGs in their molecular structure.

Additional information on geogrid durability is available in *Corrosion/Degradation of Soil Reinforcements for Mechanically Stabilized Earth Walls and Reinforced Soil Slopes* (Ref. 8).

Based upon the guidelines established by the Federal Highway Administration, polyester geogrids submitted for approval should meet the following minimum criteria:

- Have a current NTPEP evaluation report.
- Molecular weight greater than 25,000 g/mol.

- Carboxyl End Group less than 30 mmol/kg.
- Product specification certification, which must originate from the actual manufacturer of the fiber to show conformance with the specification.

2.3 GEOTEXTILE MATERIAL (FILTER FABRIC)

As with geogrid materials, geotextiles should have a current NTPEP evaluation report and comply with AASHTO M288 criteria (Ref. 18). Refer to Section 10.2.3 of the NCMA SRW Design Manual (Ref. 1) for additional information on the design of geotextiles. Additional considerations for geotextiles include:

- Geotextiles should have a high transmissivity so as to not impede water flow.
- Geotextiles should not to be prone to clogging by the reinforced soil and in special cases the retained soils. An example of a special case would be using drain stone for the reinforced soil in waterfront applications where the geotextile is provided to prevent fines migration from the retained soil. Avoid the use of woven slit film or non-woven heat bonded products.

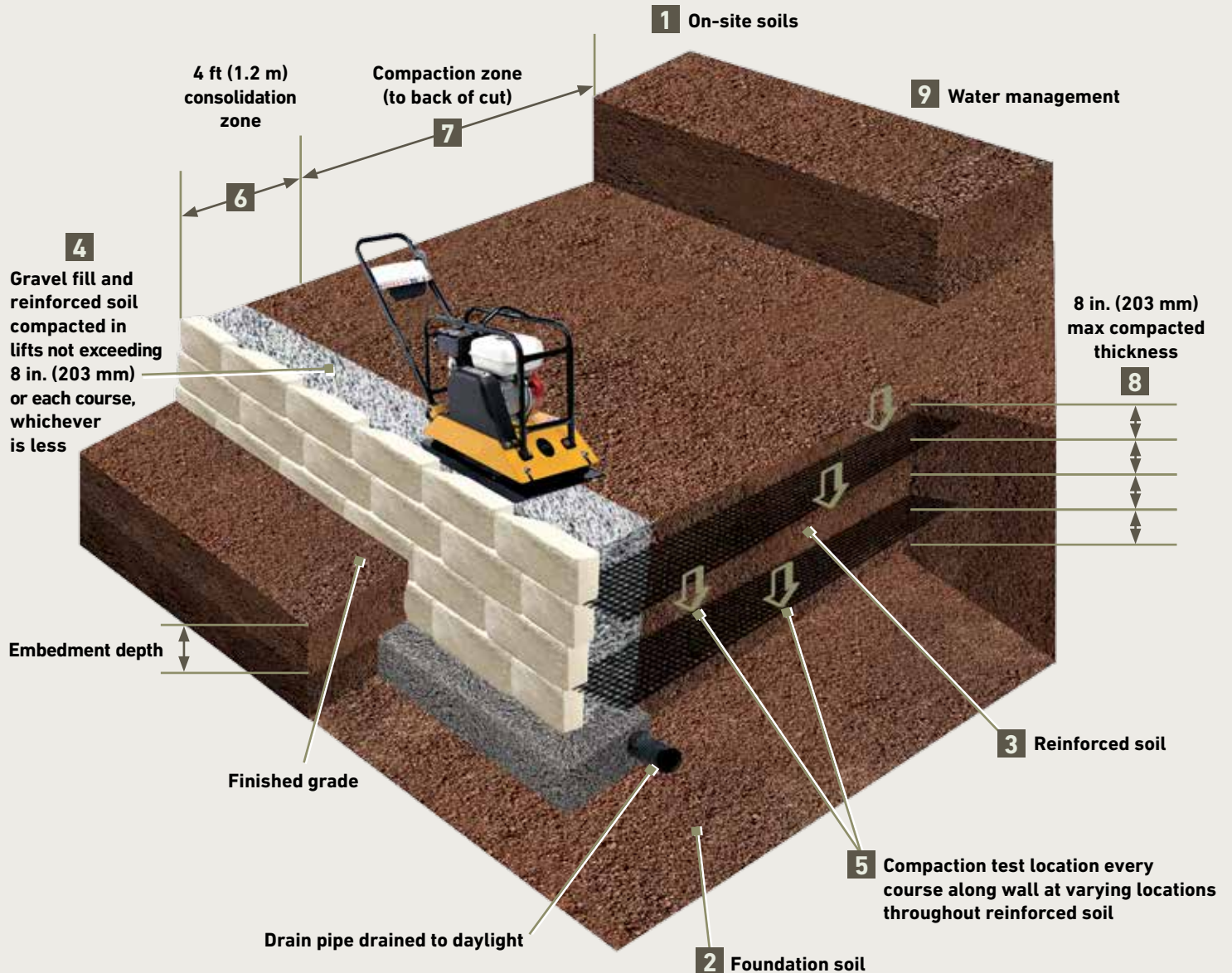

Figure 3 | Soils and Compaction

- 1 On-site soils** – see Section 3.1.
- 2 Foundation soils** – see Section 3.2.
- 3 Reinforced soils** – see Section 3.3.
- 4 Gravel fill** – See Section 3.5.
- 5 Soil testing** – frequency should be set to verify proper compaction has been achieved. See Sections 3.8 and 7.2.
- 6 Consolidation zone** – use only hand-operated equipment. See Sections 3.6 and 5.5.
- 7 Compaction zone** – heavy equipment should be used in the compaction zone. See Section 5.5.
- 8 Soil lifts** – maximum fill and compaction lifts of 8 in. (203 mm) (Section 5.5), or less with fine-grained soils.
- 9 Water management** – implement temporary berm or grade the backfill at day's end to avoid water accumulation behind the wall and compact any over excavated spoils (Section 5.6).

Chapter Summary

Understanding site soils and proper minimum soil parameters for reinforced soil as well as proper drainage requirements are essential to designing and construction a wall properly. Key topics reviewed in this chapter include: on-site soils, foundation soils, reinforced soils, retained soils, gravel fill, compaction requirements, and testing and inspection of soils.

3.1 ON-SITE SOILS

Understanding the on-site soils (the retained and foundation soils, and depending on suitability, the reinforced soils), as well as the imported soils (the gravel fill, leveling pad, and where the on-site soils are not suitable, the reinforced soils) is essential to understanding how the retaining wall will function. Soils in a reinforced SRW represent about the 90% of the system and without an adequate understanding of these soils it is impossible to successfully design a reinforced soil retaining wall.

3.2 FOUNDATION SOILS

The foundation soils under segmental retaining walls need to provide adequate support to the structure without excessive settlement. The recommendations for foundation soils are as follows:

- The project geotechnical report should include parameters and recommendations for foundation soils including strength and weight parameters, allowable bearing capacities based on an appropriate factor of safety for the wall application taking into account retaining wall bearing width, embedment and flexibility, and anticipated total and differential settlements for the retaining wall.
- Prior to the design of the retaining wall, the foundation soils need to be evaluated by the project geotechnical engineer to ensure these soils are suitable for support of the proposed structure (For

short walls less than 10 ft (3 m), verification may also be accomplished by the engineer of record if appropriately qualified.). Cohesion values are allowed in the foundation soil for the global stability analysis and determination of bearing capacity, but only if these soils are undisturbed, naturally deposited soils. *Do not use cohesion values in fill soils.* It is recommended that no more than 10% of the tested/reported values be used because soil cohesion will vary with time and moisture content. Similar recommendations would apply to the retained soils, if undisturbed.

- After rough excavation and prior to construction of the retaining wall, the exposed foundation soils should be evaluated by the project geotechnical engineer. If poor soils are encountered during construction, the project geotechnical engineer should provide recommendations with respect to removal and replacement of the poor soils, possible soil improvement recommendations, or other appropriate remediation methods. Depending on the magnitude of the soil improvements required, a specialized foundation improvement contractor may need to be retained by the owner. The geotechnical should also look for any evidence of groundwater seeps and notify the SRW Design Engineer if groundwater is evident beyond what was considered in the original design. The entire footprint of the

reinforced zone from the face of the wall to the end of the reinforcement should be evaluated.

3.3 REINFORCED SOILS

One of the economic advantages of an SRW system is that a range of soils can generally be used in the reinforced soil zone provided that surface and groundwater conditions at the site are controlled by recommendations given in Chapter 4. The reinforced soil, however, should meet the NCMA recommended gradation as shown in Table 3.3-1.

Cohesionless, free draining materials (less than 50% passing a number 40 sieve and less than 10% passing a number 200 sieve) are always preferred. These include well-graded and poorly graded gravels (GW and GP soils), well-graded and poorly graded sands (SW and SP soils), and poorly graded gravels and sands containing silt (GP-GM and SP-SM soils). Soils that do not meet the No. 40 and No. 200 gradation requirements of Table 3.3-1 with relatively low plastic fines (i.e. clayey sand (SC) with a plasticity index (PI) less than 20 and liquid limit (LL) less than 40) may be used for lower height SRW construction (less than 10 feet (3 m)) provided the following additional design criteria are implemented:

- Proper internal drainage is installed including gravel fill in, between, and behind the facing along with blanket and chimney drains to keep the reinforced mass dry as discussed in Chapter 4.

Table 3.3-1 | Reinforced Soil Gradation Recommendations²

Sieve Size	Percent Passing
1 in. (24 mm) ¹	100
No. 4	100-20
No. 40	0-60
No. 200	0-35

¹Larger aggregate size can be considered if the geosynthetic reinforcement has been assessed for full-scale installation damage testing using similarly graded backfill.

²See Table 8.1.1-1 for gradation recommendations for tall walls.

- In areas where frost heave is possible, only soils with low to moderate frost heave potential should be utilized. Extending the depth of gravel fill behind the facing can help reduce the effects of frost heave/swelling. See Section 3.5 for additional information on the gravel fill column.
- The soil's shear strength (total and effective) should be provided by the project geotechnical engineer. The cohesion (*c*) for the reinforced fill soils, should be ignored for internal and external stability analysis.

These conditions are applicable provided that:

- 1) A geotechnical engineer is involved in the design to ensure the proper definition of the total and effective soil strength parameters; and
- 2) A geotechnical engineer verifies that the soils are not susceptible to time-dependent behavior (creep). Verification may be performed by the engineer of record for walls less than 10 ft (3 m) in height, if qualified to do so.

As previously discussed, additional care in backfilling, compaction, and water management, such as blanket drains and chimney drains, is required.

For walls between 10 and 20 feet (3 to 6 m) in height, the NCMA recommended gradation shown in Table 3.3-1 is recommended; however it is recommended that the plasticity index (PI) be less than 6.

When walls exceed 20 feet (6 m) in height, select structural backfill should be used in the reinforced soil zone. The top 10 feet (3 m) of the reinforced soil can comply with Table 3.3-1 for walls over 20 feet (6 m) in height. A recommended gradation for select structural backfill for tall walls is provided in Chapter 8.

Where site soils are to be used in the reinforced zone, the geotechnical

engineer will need to field verify the soils meet the minimum requirements set forth in the soils report, and the soils are in compliance with the soil strength and weight parameters used in the design process.

High plastic or organic soils including MH, CH, OH, OL and PT are not recommended for any segmental retaining wall construction.

The entire reinforced soil zone should be compacted to a minimum of 95% of the standard Proctor density, ASTM D698 (Ref. 19) or 92% of the Modified Proctor Density, ASTM D1557 (Ref. 20). As a general rule, the moisture of the soil should be within +/- 2 percentage points of the soil's optimum moisture content, however, every soil behaves differently with respect to maximum density and optimum moisture content. Some soils will lose shear strength at moisture contents over optimum and others can be susceptible to compression if placed too dry of optimum. It is best to work with the geotechnical engineer to establish appropriate moisture control criteria for the soils used.

Backfilling the wall is accomplished as each course of wall is placed. Stacking 2 or 3 courses at a time prior to fill placement and compaction is not a recommended practice. Maximum thickness of soil lifts will be dependent on the soil type and the available compaction equipment on site, however at no time should the compacted lift thickness exceed 8 in. (203 mm).

3.4 RETAINED SOILS

Although retained soils are most commonly thought of as the undisturbed native soil at the back of a cut slope to which the reinforced soils butt up against, they can also include any native or imported backfill material located behind the reinforced soils.

When retained soils are required to be backfilled, granular soils are preferred but it is also common to use on-site soil that can be adequately compacted. Compact the retained soils to meet the specified densities and strength parameters in the wall design. They should be compacted to a minimum of 95% of the standard Proctor density (or as directed by the project geotechnical engineer). The soils should be compacted in no more than 8 in. (203 mm) compacted lift thickness.

Where slopes are present above the wall, the slope soil should be compacted with the same effort as the retained soil.

3.5 GRAVEL FILL

The gravel fill column should be a minimum 12 inches (305 mm) deep, measured from the back of the wall unit and a minimum of 24 inches (600 mm) deep measured from the face (i.e. For a 10 inch (254 mm) deep unit, there needs to be 14 inches (356 mm) of gravel behind the wall unit). The gravel fill also needs to be placed in and between the SRW units.

The gravel fill must be clean, compactable, and free-draining gravel with no more than 5% passing the #200

Table 3.5-1 | Gravel Fill Gradation Recommendations

Sieve Size	Percent Passing
1 in. (24 mm)	100
¾ in. (19 mm)	75-100
No. 4	0-60
No. 40	0-50
No. 200	0-5

sieve. The NCMA recommended gravel fill gradation is shown in Table 3.5-1. If the gravel fill is considered gap graded (i.e. #57 stone), and the backfill material is fine-grained and capable of migrating into the gravel fill, the SRW design engineer should consider whether a filter fabric should be placed between the reinforced soil and the gravel fill column in order to prevent piping of the finer grained soils through the wall face. Filter fabric design is covered in the NCMA design manual (Ref. 1).

At the top of the wall, above the gravel fill column a horizontal layer of landscape fabric is recommended to protect the gravel fill from being infiltrated by the top soil.

3.6 COMPACTION REQUIREMENTS AT THE WALL FACE

Hand operated compaction equipment is generally used within the 3 feet (0.9 m) of the back of the wall units (4 feet (1.2 m) measured from the face of the wall). Compaction will begin by running the compactor in parallel paths, working away from the wall face, until the entire area has been compacted to the project specifications. When using hand operated compaction equipment, the loose lift thickness may be less than previously discussed in order to meet the minimum compaction requirements.

Final compaction requirements within 4 ft (1.2 m) of the wall face will be established by the SRW design engineer. The compaction level should be provide the equivalent of 95% of Standard Proctor. If the contractor is unable to obtain the required compaction in the consolidation zone, then the compaction lift thickness should be reduced. If the

compaction standard still cannot be obtained, then the entire zone should be replaced with gravel fill per Chapter 8.

3.7 SOIL PARAMETER VERIFICATION

The project geotechnical engineer, retained by the owner, should verify and document that soils used for wall construction meet or exceed those specified in the geotechnical report and retaining wall design. Soil verification should be done prior to beginning construction activities and repeated as necessary to ensure compliance throughout construction.

3.8 INSPECTION AND TESTING RECOMMENDATIONS

In the project specifications, establish inspection and testing requirements in advance of providing a wall design. While quality control is generally considered to be the responsibility of the wall contractor, quality assurance is the responsibility of the owner. The owner should retain the services of an independent testing and inspection firm, which may be the project geotechnical engineering company, to provide quality assurance for the project.

The independent inspection and testing firm must keep inspection logs and provide written reports at predetermined intervals to the owner.

The size and scope of the project will influence the level of testing and inspection. Testing frequency should be set to establish a proper compaction protocol to consistently achieve the minimum specified compaction requirements set by

the design requirements. If full time inspection and testing is not provided, and in the absence of criteria from the geotechnical engineer, then the minimum testing frequency should include one compaction test for each soil lift, (not exceeding 8 in. (203 mm)) but not less than one test for every 50 cubic yards (38 cubic meters) of compacted fill at a spacing not to exceed 100 ft (30 m).

Vary compaction test locations to cover the entire area of the reinforced zone, including the area compacted by the hand-operated compaction equipment within 4 ft (1.2 m) of the wall face.

At the beginning of backfill operations, develop a compaction protocol to achieve the specified density, including:

- lift thickness;
- type of compaction equipment;
- minimum number of passes; and
- frequency of density testing.

After a protocol has been established and testing confirms results are consistent, the required number of field compaction tests can be reduced. If materials or equipment change, establish a new protocol.

If different than the reinforced soil, fill slopes placed above the wall must meet the soil strength parameters of either the reinforced or retained soil and must be compacted, inspected and tested in a similar manner as that of the reinforced or retained soil.

Refer also to Chapter 7 for additional discussion on testing and inspection.

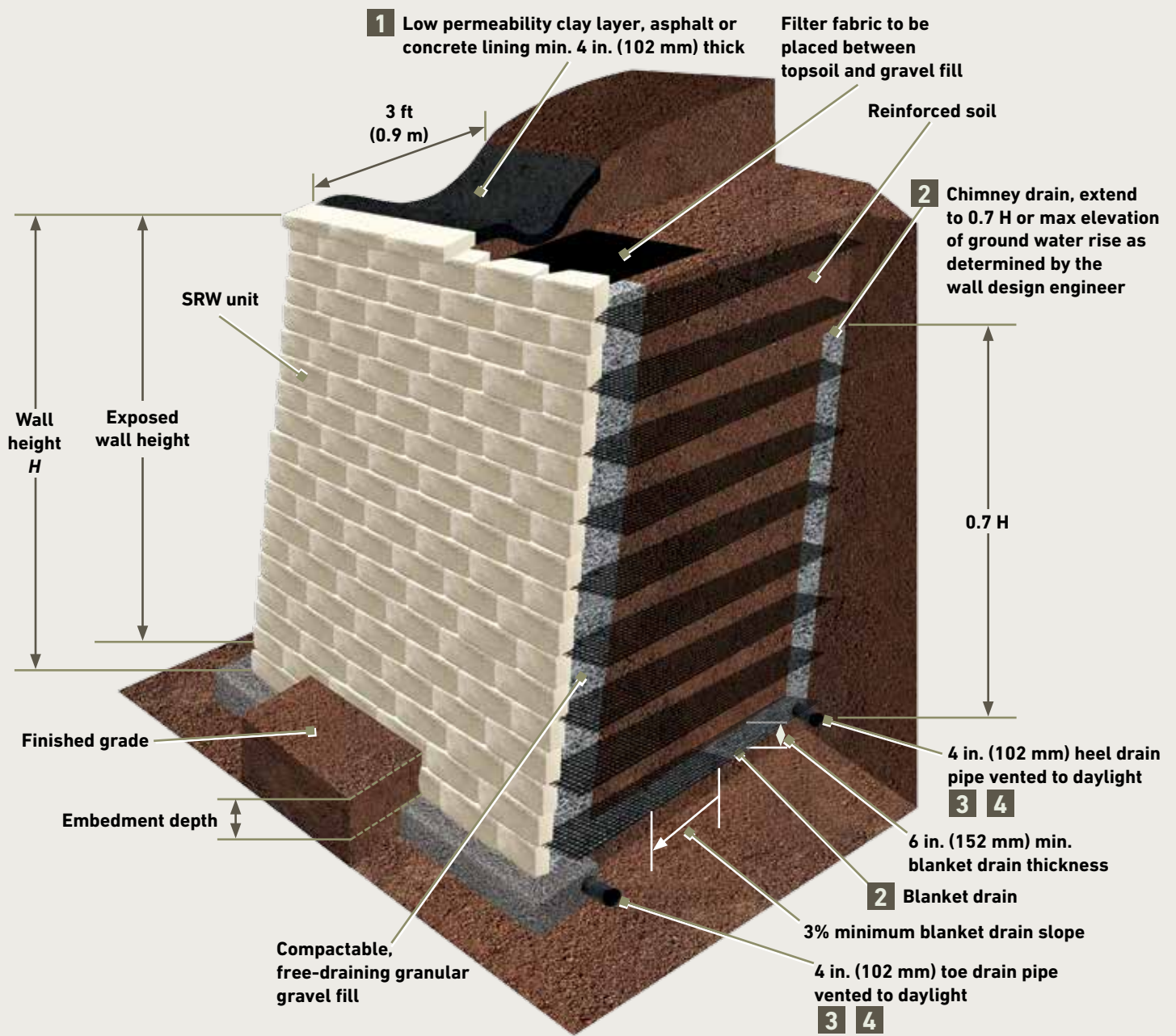

Figure 4 | Water Management Considerations

- 1 Swales** – backslopes should have swales so water is not allowed to flow over the top of the wall. See Section 4.1.1.
- 2 Drains** – blanket and chimney drain should be used if migratory subsurface water is suspected or using reinforced soils with poor drainage. See Section 4.1.2.2.
- 3 Drain pipe** – typically 4 in. (102 mm) perforated flexible drain pipe or rigid perforated drain pipe. See Sections 4.1.2.1 and 5.3.

- 4 Venting** – all drain pipes must exit to daylight or be connected to an underground drainage system. (Section 4.1.2)

* Refer to Figure 1 for general notes and details

Chapter Summary

Ignoring, or improperly accounting for, water management on a site is a frequent source of performance issues of any retaining wall system. This chapter summarizes recommendations and issues to take into consideration whether dealing with above grade water sources or below grade water sources. For additional information on using SRW systems with water features (detention or retention ponds, channels, etc.) refer to Chapter 11 of this Guide.

4.1 WATER MANAGEMENT

Water can increase loads on a retaining wall, be a source of scour or erosion, or decrease the stability of soils surrounding a SRW. Whenever possible, water should be directed away from retaining walls. When water does reach a SRW, providing proper drainage components will reduce the loading on the wall and mitigate potential maintenance or performance issues.

4.1.1 Surface Water

The wall designer must identify localized water sources, such as storm

drains and drop structures, and consult with the site civil engineer to ensure that water will not be introduced into the reinforced mass. Considerations include:

- Site topography should drain surface water away from the top and bottom of the wall.
- Where necessary, slopes above walls should have swales incorporated so water is not allowed to flow over the top of the wall. Figure 4.1.1-1 shows two typical drainage swale details, one

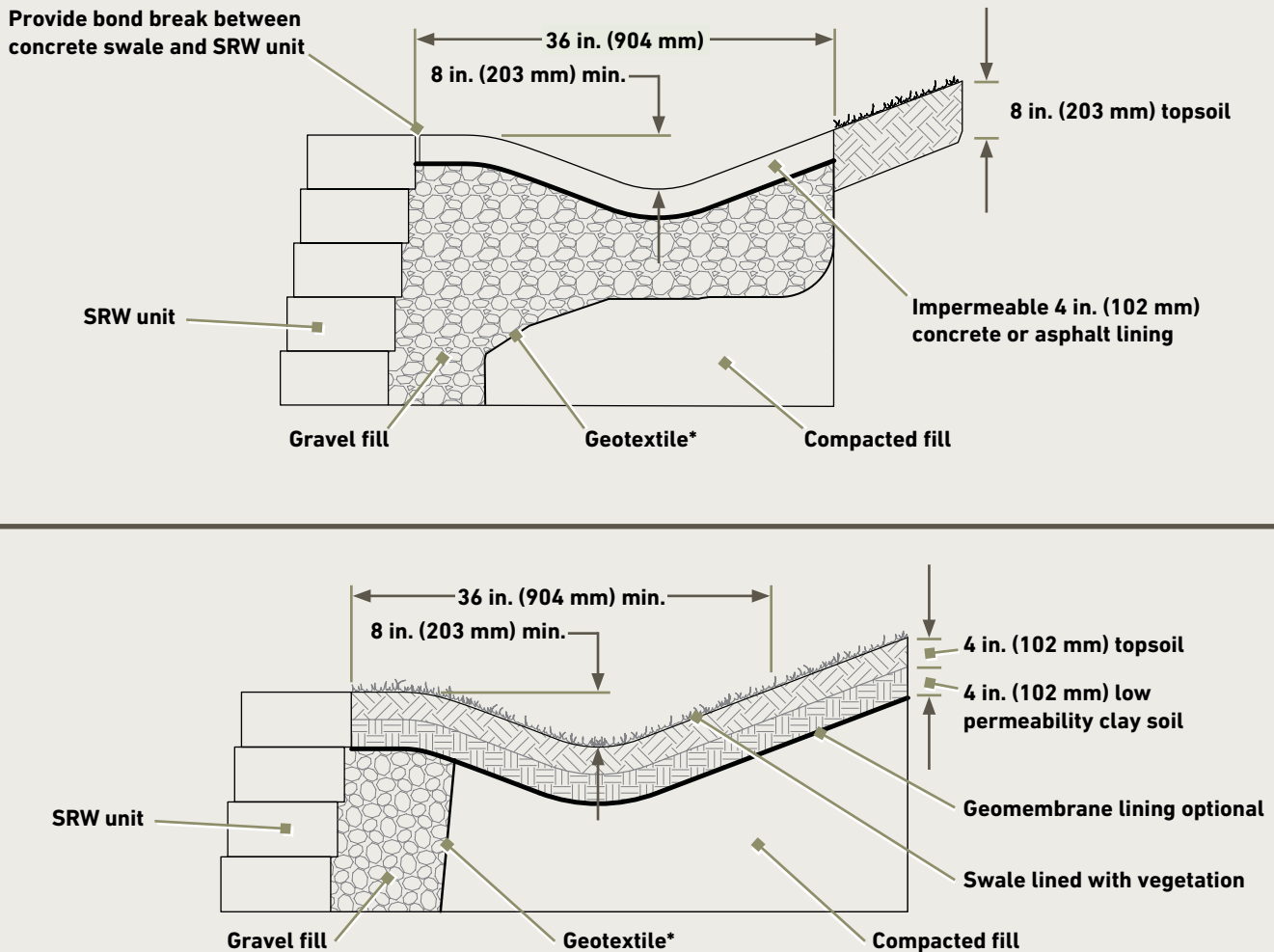

*Geotextile may be necessary when the infill soil includes fine-grained sand that have the potential to infiltrate the gravel fill

Figure 4.1.1-1 | Drainage Swale Details

for a vegetated swale and the other detail for a concrete or asphalt lined swale. Alternatively, a curb and gutter may be used. In either case, the swale or gutter should be sloped to direct water away from the wall face. A geotextile should be used below the impermeable soil to avoid the migration of fine soil particles.

- During construction, surface water must be directed away from partially constructed walls at the end of each day.

4.1.2 Below Grade Water

4.1.2.1 Drainage Pipe Placement

The function of the drain pipe is to remove incidental water from the gravel

fill so that it does not accumulate, which if not removed results in increased internal forces on the SRW. The design of the drainage system may include both solid and perforated pipe. The solid pipe is used when transporting water to the discharge location and the perforated pipe is used when collecting and transporting water. Additional considerations include:

- While discouraged, if there are utilities within the reinforced zone, place gravel around them to generate good compaction.
- Additional gravel fill and filter fabric should be added around all storm drains and drop structures to aid in drainage in the event unintended leakage occurs.

- Provisions, such as check valves, to prevent flooding from broken lines or heads must be put in place to stop over irrigation above walls.
- Where necessary, wrap the gravel fill from the top of the gravel fill down to the top geogrid layer with a geotextile to reduce infiltration of fines into the gravel fill.

If mitigating surface or ground water is a concern, the drainage details of Section 4.1.2.2 should be considered. Where only incidental water is expected, the detailing options of Figures 4.1.2-1, 4.1.2-2, and 4.1.2-3 provide sufficient means of collecting and removing water from the gravel fill. Conditions for the recommended use of Figure 4.1.2-1 include:

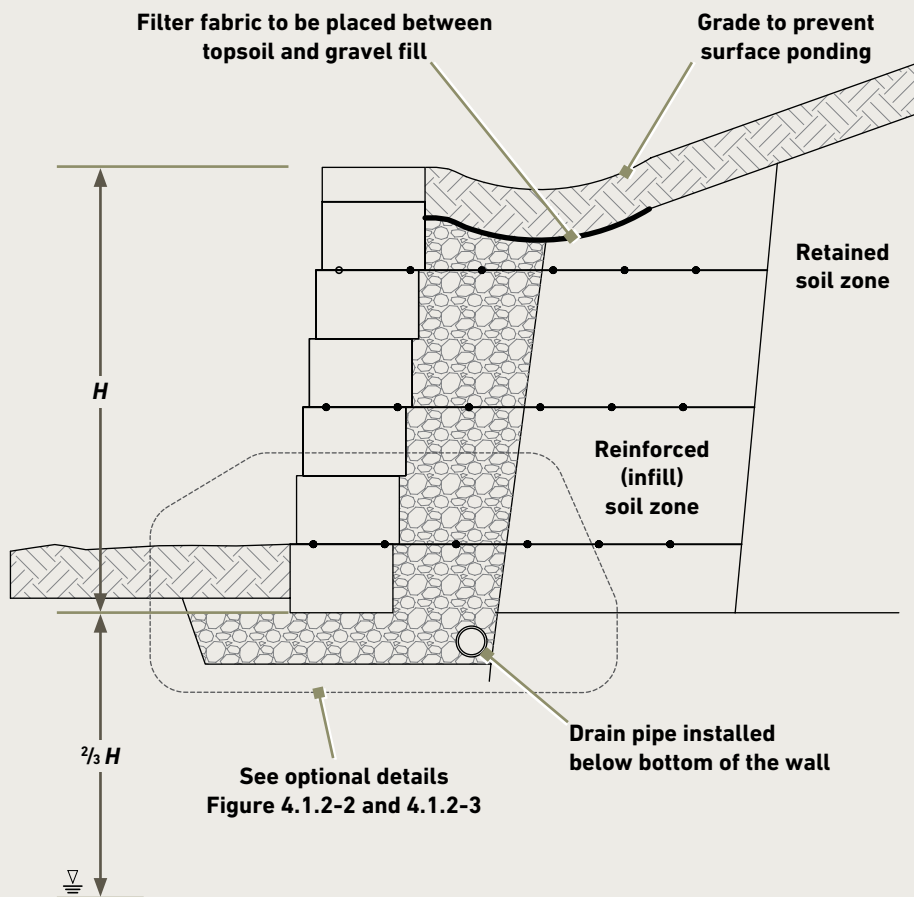

Groundwater Conditions

1. Groundwater table at a minimum of $\frac{2}{3}H$ below the bottom of the wall (∇)
2. Negligible lateral (horizontal) groundwater flow into reinforced and retained soils

Figure 4.1.2-1 | Incidental Water Drainage; Drain Pipe Located at Base of Gravel Fill

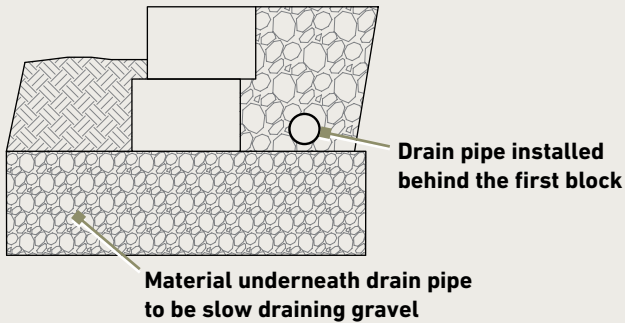

Figure 4.1.2-2 | Optional Drain Pipe Location; Behind Base SRW Unit

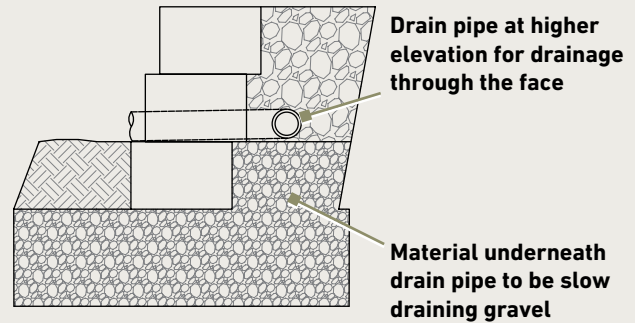

Figure 4.1.2-3 | Optional Drain Pipe Location; Above Base SRW Unit

- The groundwater table is located at least two-thirds of the wall height (2/3H) below the bottom of the wall.
- There is negligible flow of water into the reinforced and retained soil zones.

There are several options available for the placement location of the drain pipe to satisfy varying project challenges:

- **Base of Gravel Fill** – Where the leveling pad and gravel fill is of the same material, locating the drain pipe at the base of the gravel fill column as illustrated in Figure 4.1.2-1 is an effective means of removing incidental water from

the gravel fill. Water collected is transported laterally to the discharge location.

- **Behind Base Unit** – Where desired, the drain pipe can be located on the leveling pad behind the base unit of the SRW as shown in Figure 4.1.2-2. For such installations, the leveling pad material should be densely compacted, slow draining material to slow the infiltration of water into the leveling pad. As with locating the drain pipe at the base of the gravel fill, the collected water is transported laterally to the discharge location.
- **Above Base Unit** – When the drain pipe needs to be raised to

accommodate outlets through the wall face, low permeable granular soils should be used to create a shelf inside the mass, level to the height of the finished grade outside the wall to prevent water from ponding below grade. This option is illustrated in Figure 4.1.2-3. The relatively low permeability soil should consist of a densely compacted, slow draining material.

In addition to a toe drain, a heel drain can be used where migrating water from behind the soil mass is possible as shown in Figure 4.1.2-4. The purpose of the heel drain is to pick up any water that migrates from behind the retaining wall structure at the cut, and route the water away from the reinforced mass

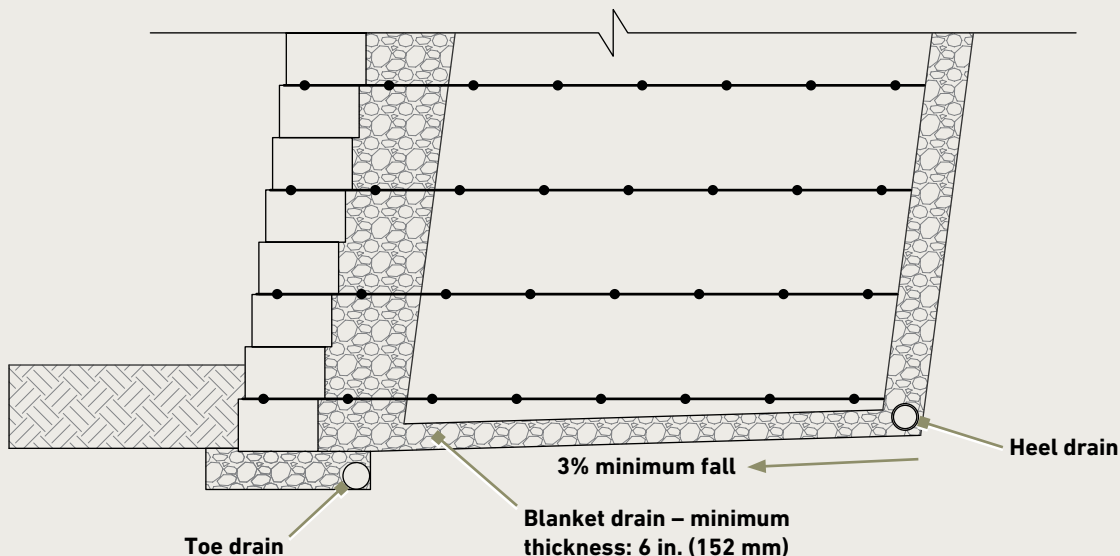

Figure 4.1.2-4 | Heel and Toe Drain Locations

during construction and for incidental water for the life of the structure. Additional considerations for heel drains include:

- The piping used at the back of the reinforced mass should have a one percent minimum gradient over the length and should be placed as low as feasible while still allowing daylight discharging.
- The heel drain should be vented at 100 foot (30 m) intervals along the entire length of the wall. The heel and toe drain can be tied together, although keeping them separate does provide the ability to identify source(s) of water with greater ease.
- The pipe may be a rigid pipe with holes at the bottom or a corrugated perforated flexible pipe.

- For reinforced soils with a high percentage of sand and/or gravel the heel drain pipe does not need to be surrounded by gravel. When working with fine-grained soils, 1 ft³ per foot (0.09 m³ per meter) of clean gravel is required around the pipe.

4.1.2.2 Blanket and Chimney Drains

When project conditions warrant, the use of a blanket drain or combination blanket and chimney drain can be used to mitigate a wide range of potential water infiltration problems. Project conditions that may necessitate the use of blanket and/or chimney drains include:

- When the groundwater table is expected to rise to, or remains just below, the leveling pad elevation during the design life of the structure.

- When the groundwater table is expected to seasonally rise above the bottom of the leveling pad elevation.
- Where there is a perched water table or body of water behind the reinforced zone.
- Where groundwater flows laterally into the reinforced/retained soil zone or surface water runoff is not diverted away from the reinforced/retained soil zone.
- If site soils are used that do not have granular characteristics, a chimney and blanket drain should be considered to ensure the reinforced mass stays as dry as possible. Unless otherwise directed by the geotechnical engineer, a blanket and chimney drain should be used when reinforced soils have

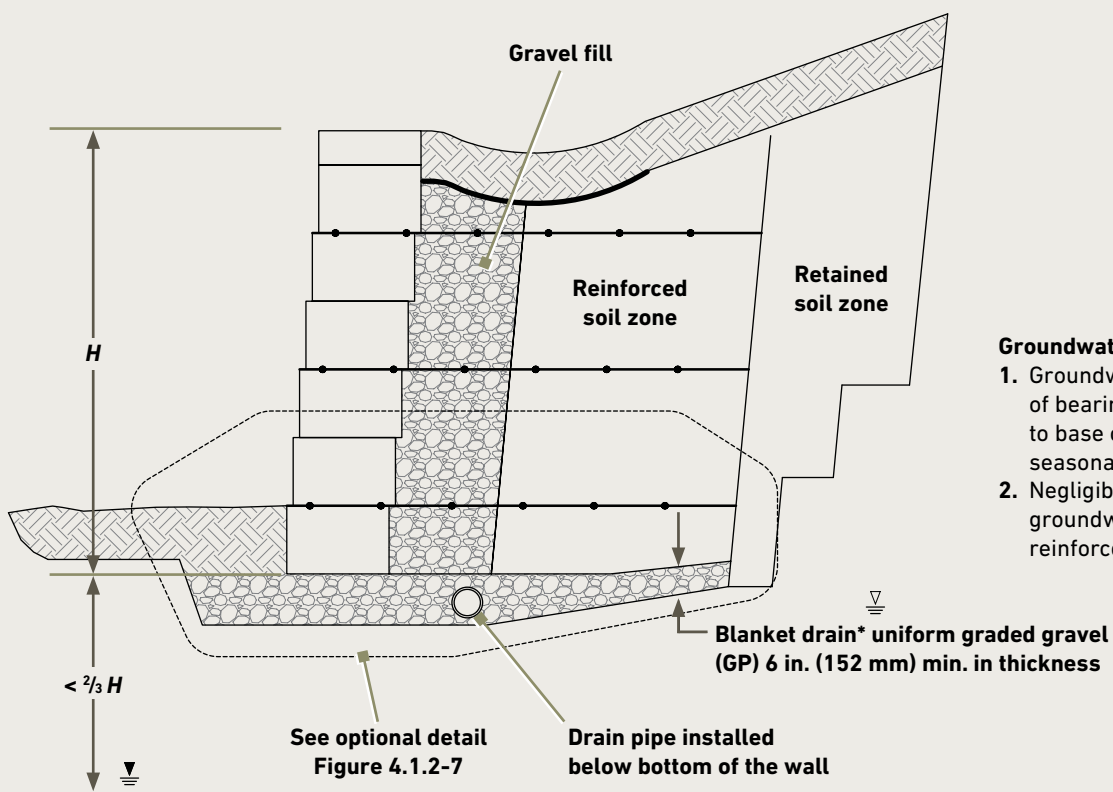

Groundwater Conditions

1. Groundwater table near bottom of bearing pad (∇) or could rise to base of reinforced soil on a seasonal basis (∇).
2. Negligible lateral (horizontal) groundwater flow into reinforced and retained soils.

*Chimney drain and/or blanket drain may be replaced with an appropriate geocomposite at the discretion of the wall design engineer.

Figure 4.1.2-5 | Blanket Drainage System

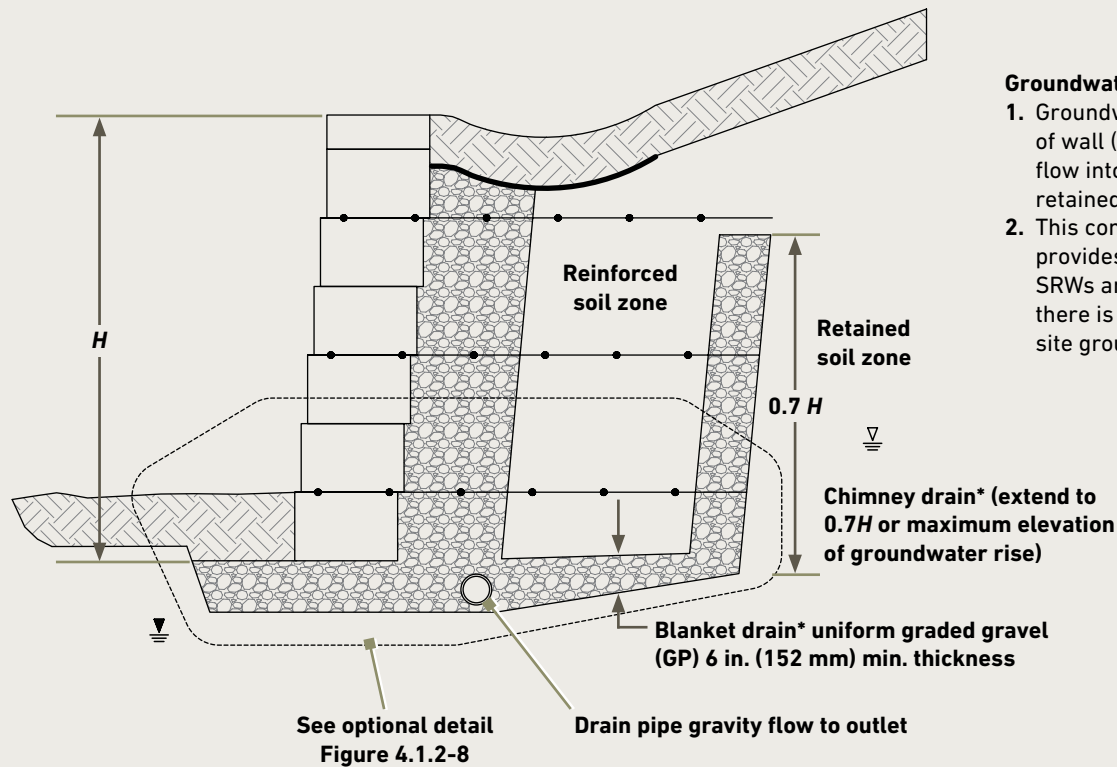

Groundwater Conditions

1. Groundwater table near bottom of wall (∇) or lateral (horizontal) flow into reinforced soil and retained soil (∇).
2. This complete drainage system provides maximum protection for SRWs and should be utilized when there is uncertainty as to the actual site groundwater conditions.

*Chimney drain and/or blanket drain may be replaced with an appropriate geocomposite at the discretion of the wall design engineer.

Figure 4.1.2-6 | Combination Blanket and Chimney Drainage System

greater than 35% passing the No. 200 sieve.

The choice of using a blanket drain as shown in Figure 4.1.2-5, chimney drain, or combination system as shown in Figure 4.1.2-6 will depend upon not only anticipated flow volume but the source of the water as well. Detailed information for the design of blanket and chimney drains is provided in the *Design Manual for Segmental Retaining Walls* (Ref. 1). Key considerations include:

- The drainage systems must have adequate thickness and permeability to carry anticipated flows and be constructed with an appropriate gradient to the drain pipes.
- All drain pipes should be sized for adequate flow capacity and sloped to direct intercepted flows by gravity to locations beyond the SRW structure.
- In most cases the gravel fill should be encapsulated by an appropriately selected geotextile filter to prevent ingress of finer soils that may clog the coarser sized gravel fill materials over time.
- The thickness of the blanket drain should not be less than 6 inches (152 mm).
- The chimney drain should extend to an elevation in excess of the maximum anticipated groundwater elevation behind the structure, or approximately 70% of the wall height (0.7H), whichever is greater.
- A prefabricated drainage composite may be utilized as an alternate with approval of the geotechnical and/or the SRW design engineer.
- External stability calculations should include analyses of potential sliding along geotextile or geocomposite interfaces, as applicable.
- Alternative drain pipe locations for chimney and blanket drains are illustrated in Figures 4.1.2-7, 4.1.2-8, and 4.1.2-9.

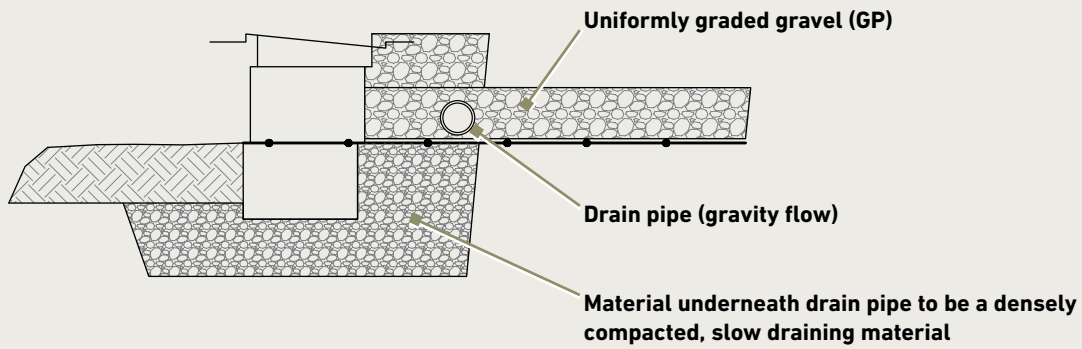

Figure 4.1.2-7 | Alternate Drain Pipe Location with Blanket Drain

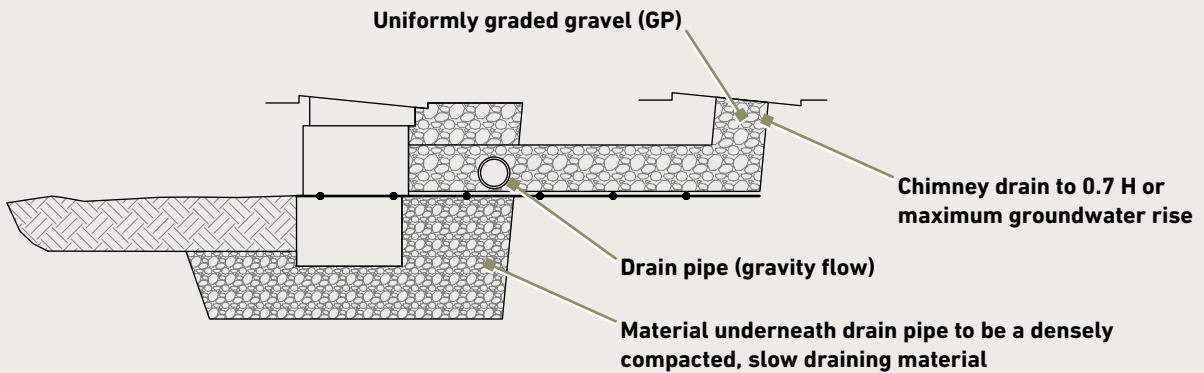

Figure 4.1.2-8 | Alternate Drain Pipe Location with Blanket Drain and Chimney Drain

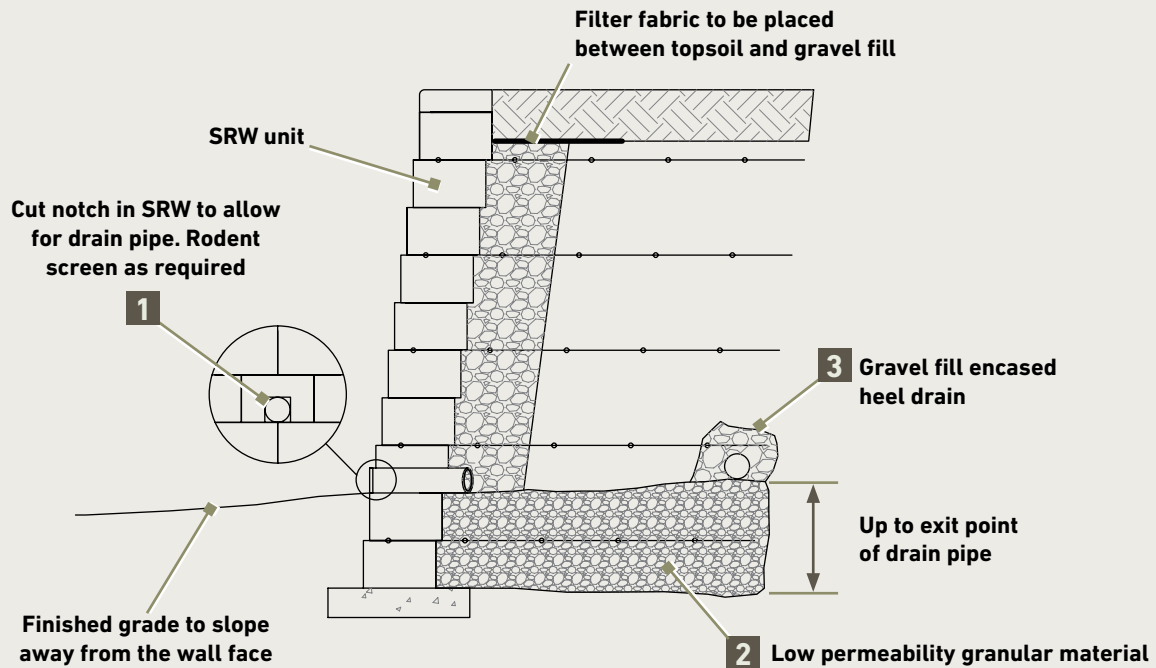

Figure 4.1.2-9 | Alternate Drain Pipe Detail

- 1 Drain pipe raised to accommodate outlets through the wall face.
- 2 Low permeability granular material should be placed to avoid ponding.
- 3 1 ft³/ft (0.3 m³/m) of additional gravel fill should be placed around heel drain when the reinforced soil used is a fine-grained soil.

A successful SRW project depends not only on good design, but good workmanship practices during the construction phase. NCMA recommends SRW installers are trained and certified by a nationally recognized SRW installer certification program, such as NCMA's SRW Installer Certification program, or equivalent.

5.1 CONTRACTOR EXPERIENCE

Even the best designs are prone to performance problems if poorly executed in the field. While the process of constructing an SRW structure may appear to be intuitively simple, there are many nuances to SRW construction that are learned through experience. When SRW installers have a working understanding of project variables and the impact of poor workmanship, a multitude of potential performance issues resulting from poor construction practices can be mitigated. SRW installers working on projects within the scope of this Guide should be well versed not only in the best practices outlined in this Guide, but their role in the successful completion and ongoing performance of a project.

- While NCMA's SRW Installer Certification program requires a minimum level of SRW construction experience for the initial certification (which includes successfully completing at least three projects and at least 2,500 ft² (232 m²) of installed wall area) as well as ongoing education to maintain the certification, one should consider the type of experience an SRW installer has and whether it is appropriate for each specific project. If, for example, a project has complicated features such as tall walls, terraces, water features, project scheduling, or demanding timelines, the SRW installer should have successful experience in similar projects.
- Recommendations for post-construction assessment and monitoring are provided in NCMA's SRW article, *Assessment*,

Maintenance, and Repair of SRWs (Ref. 15).

5.2 LEVELING PAD

The leveling pad provides the initial working surface during construction as shown in Figure 5.2-1. If the leveling pad is not level when units are being installed, the resulting wall will not be level. General guidance on the construction of leveling pads includes:

- Excavate the trench to accommodate the designed thickness of the leveling pad plus the embedment depth for the project conditions. The minimum thickness for the leveling pad should not be less than 6 in. (152 mm).
- The base trench should be compacted to the density specified in the geotechnical report and inspected by the onsite geotechnical engineer prior to any base material being placed.
- The recommended gradation for leveling pads is a densely compacted gravel or unreinforced, low strength concrete, unless otherwise necessary. Avoid pea gravel (poorly graded, single size round gravel).
- For wall bases on poor foundation soils, consult geotechnical engineer's preparation recommendations.

- In situations where gravity flow of the wall underdrain is unattainable, the leveling pad may be constructed of a densely-graded, low permeability gravel. For this scenario, drain pipe is then located behind the SRW units above the finish grade.
- SRW units are typically placed on the centerline of the leveling pad providing a minimum of 6 in. (152 mm) extending from the front and back face of the wall. Where a drainage pipe is located at the leveling pad elevation as shown in Figure 5.1-1, extend the leveling pad width as needed to encapsulate the drain.

5.3 DRAIN PIPE

Drain pipes should meet the following material and detailing recommendations:

- Perforated or slotted PVC or corrugated HDPE pipe meeting the requirements of ASTM F405 (Ref. 9) or ASTM F758 (Ref. 10). Do not use sock pipe.
- Perforated flexible drain pipe or rigid perforated pipes with a 4 in. (102 mm) minimum diameter are recommended.
- When a perforated, rigid-pipe is used, it should be placed with holes down.

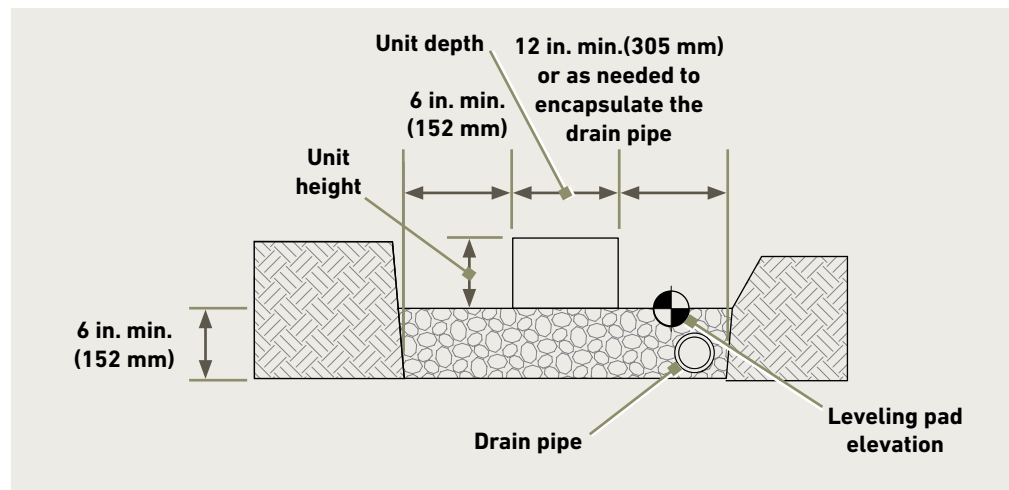

Figure 5.2-1 | Leveling Pad Construction

- The pipe and gravel fill may be wrapped with geotextile to function as a filter.
- All drain pipes must exit to daylight or be connected to an underground drainage system.
- A minimum one percent gradient should be maintained on the pipe with outlets at a maximum of 50 feet (15 m); or 100 feet (30 m) if the pipe is crowned between the outlets.
- All pipe outlets should be configured to be protected from crushing or plugging.

5.4 SRW UNIT PLACEMENT

- Erect units in accordance with manufacturer's instructions and recommendations, and as specified on the plans.
- Place first course of SRW units on the leveling pad. Check units for level and alignment. Maintain the same elevation at the top of each unit within each section of the base course, ensuring that base course units are in full contact with the leveling pad.
- Place SRW units side-by-side for full length of wall alignment. Alignment may be done by using a string line measured from the back of the block or other formed edge.
- Gaps between adjacent SRW base course units should not exceed $\frac{1}{4}$ in. (6 mm)
- Place gravel fill, backfill and then compact before placement of the next course.
- Remove excess fill from top of units and install next the course.
- Check each course for level and alignment. Adjust units as necessary with reinforcement shims to maintain level, alignment, and setback prior to proceeding with each additional course. Shims should be continuous and compressible and not used on courses containing geogrid between the units.

- Push the units forward until they are locked in place per the manufacturer's instructions.

5.5 COMPACTION REQUIREMENTS

- Soil lift heights should not exceed 8 inches (203 mm) following compaction.
- Only one course of SRW units should be placed at a time before backfilling.
- Hand operated plate compactors are to be used in the 3 feet (0.9 m) wide consolidation zone behind the wall (4 feet (1.2 m) as measured from the face of the wall) so as not to disrupt the stability or batter of the wall. The compactor must be at least 250 lb (113 kg).
- Compaction will begin by running the compactor in paths parallel to the wall face until the entire consolidation zone has been compacted.
- Final compaction requirements in the consolidation zone should be established by the SRW design engineer, which will typically be 95% of Standard Proctor.
- Where fine grained soils are used for the reinforced soils, additional compaction passes, and/or special compaction equipment such as a sheepsfoot roller, may be required.
- If the compaction equipment is too small to achieve the required compaction, thinner lifts should be used.
- Install each subsequent course in a similar manner. Repeat procedure to the extent of wall height.

5.6 WATER MANAGEMENT DURING CONSTRUCTION

At the end of each day's construction and at project completion, grade the backfill to avoid water accumulation behind the wall, in the reinforced zone, or running to the face of the wall.

The general contractor or general earthwork contractor should ensure that the overall site runoff is not

directed to the wall system. It is not uncommon to see washout of the leveling pad consisting of a poorly graded gravel following a large rain event if these water management considerations are not taken into account during construction.

5.7 CAPPING AND FINISH GRADING

- For walls using the manufacturers' optional capping system or approved equal, the caps should be secured in place using a high quality, flexible, exterior grade masonry adhesive approved in the project specifications.
- The grade at the top and bottom of the SRW is finished as shown on the plans and to provide for positive drainage of water away from the SRW system.
- Where the backfill above the wall slopes to the wall face, a swale should be provided to collect and direct runoff from flowing over the face of the system.
- The top of the wall should be finished with approximately 8 in. (203 mm) of a low permeable soil to cap the SRW system to reduce infiltration of surface water into the SRW reinforced soil zone. See Figure 4.
- Place finishing soil, vegetation, driveway, parking, or other structures as soon as possible to protect and avoid erosion on top and at either end of the wall.
- Filter fabric should be placed between the top of the gravel fill and the finished grade to mitigate the migration of fines into the gravel fill.

5.8 WALL STEP-UPS IN BASE COURSE

For walls with step-ups in the base course (Figure 5.8-1), extra care should be given to properly compact the base material at the end of each course to add greater stability to the next course. Ensure the minimum embedment at each step-up is maintained.

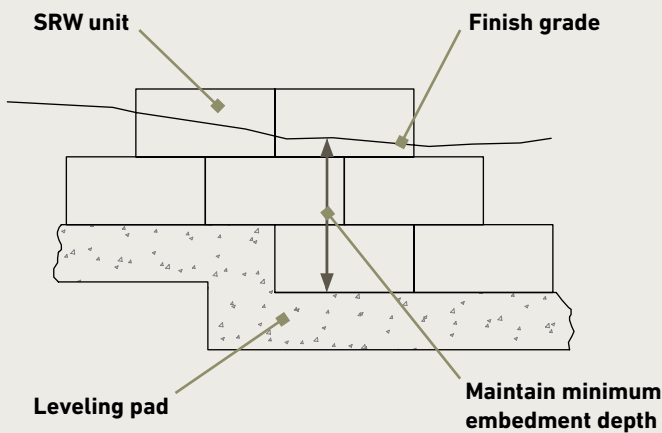

Figure 5.8-1 | Wall Step-Ups

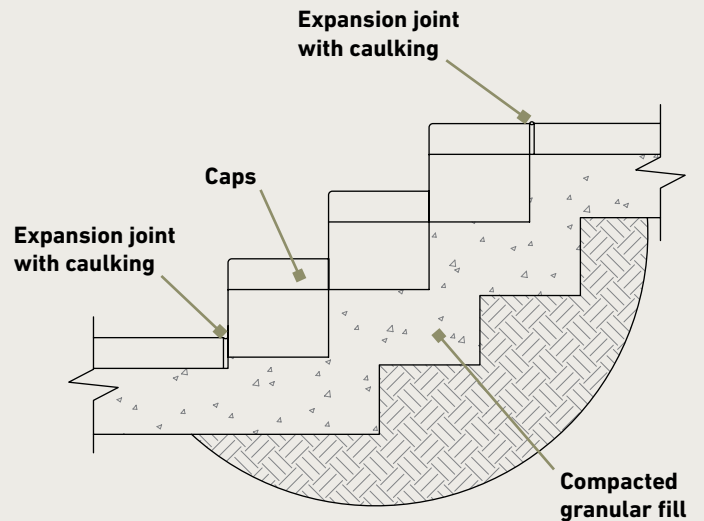

Figure 5.9-1 | Stair Construction

5.9 STAIR CONSIDERATIONS

For walls with steps built into the wall, additional compaction requirements and gravel fill should be included into the project specifications.

- A minimum of 6 inches (152 mm) of gravel base material is installed beneath each tread block, treating each course as a wall base course.
- Minimum compaction requirements for standard wall construction should be followed.
- Verify with local authorities the minimum/maximum stair riser and tread requirements.

5.10 CONSTRUCTION TOLERANCES

Any constructed work has some deviation from construction drawing alignments. One of the inherent advantages of SRW systems is that alignment, plumb, and level can be simply corrected or modified during construction. Recommended construction tolerances are defined in Table 5.10-1 and Figure 5.10-1. Project specific differential settlement limits should be defined by the owner or owner's representative and evaluated by the project geotechnical engineer.

When shimming is necessary, use strips of geogrid or asphalt shingles with a maximum nominal thickness of 1/8 in.

(3mm). Shimming should occur only at courses of block where primary layers of reinforcement are not present. Support provided by shingles or geogrid should be continuous on areas with height differences.

5.11 CONSTRUCTION SAFETY

- The contractor is required by Federal law (29CFR1926.651) to provide excavation safety for the construction workers on the site.
- Fall protection is required by Federal law (29CFR1926.501) for grade separation distances (i.e., wall heights) greater than 6 ft.

Table 5.10-1 | Construction Tolerances for SRWs

Vertical Control	± 1.25 in. (32 mm) maximum over a 10 ft (3 m) distance; 3 in. (75 mm) maximum over 100 ft (30 m)
Horizontal Location Control	straight lines: ± 1.25 in. (32 mm) over a 10 ft (3 m) distance; 3 in. (75 mm) maximum over 100 ft (30 m)
Rotation	from established plan wall batter: ± 2°
Settlement	the maximum differential settlement between two locations should not exceed 1% of the distance between the two reference points on the length of wall

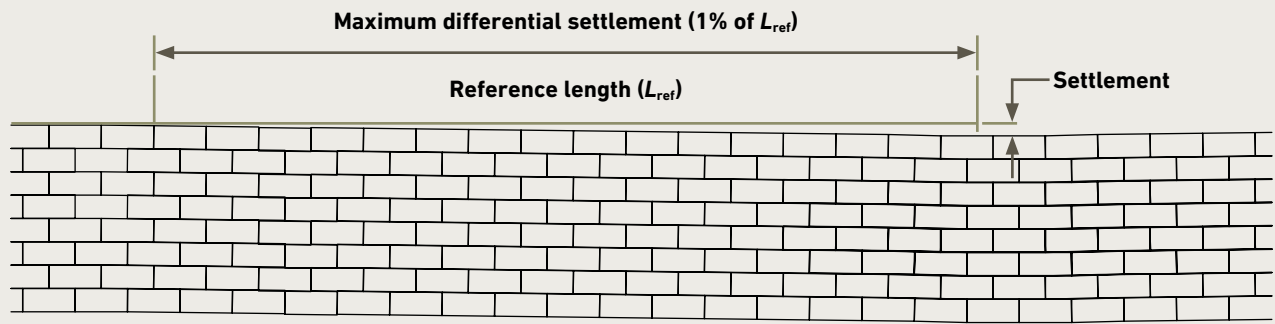

Differential settlement

Maximum rotation from specified wall batter is $\pm 2^\circ$

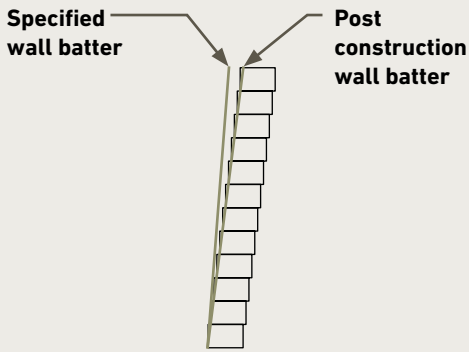

Rotation

Maximum deviation from specified alignment ± 1.25 in. (32 mm) in 10 ft (3 m); ± 3 in. (76 mm) maximum

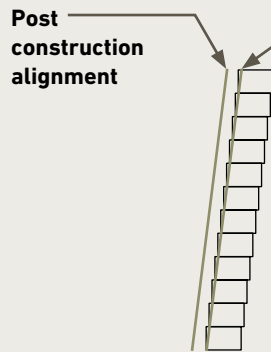

Horizontal control (alignment)

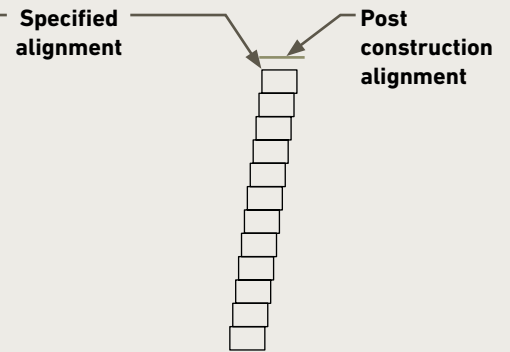

Vertical control (alignment)

Figure 5.10-1 | Recommended SRW Construction Tolerances

Notes: Alternate placement of reinforcement extension on specified reinforcement elevations.

L: Geosynthetic reinforcement design length
H: Total finished wall height

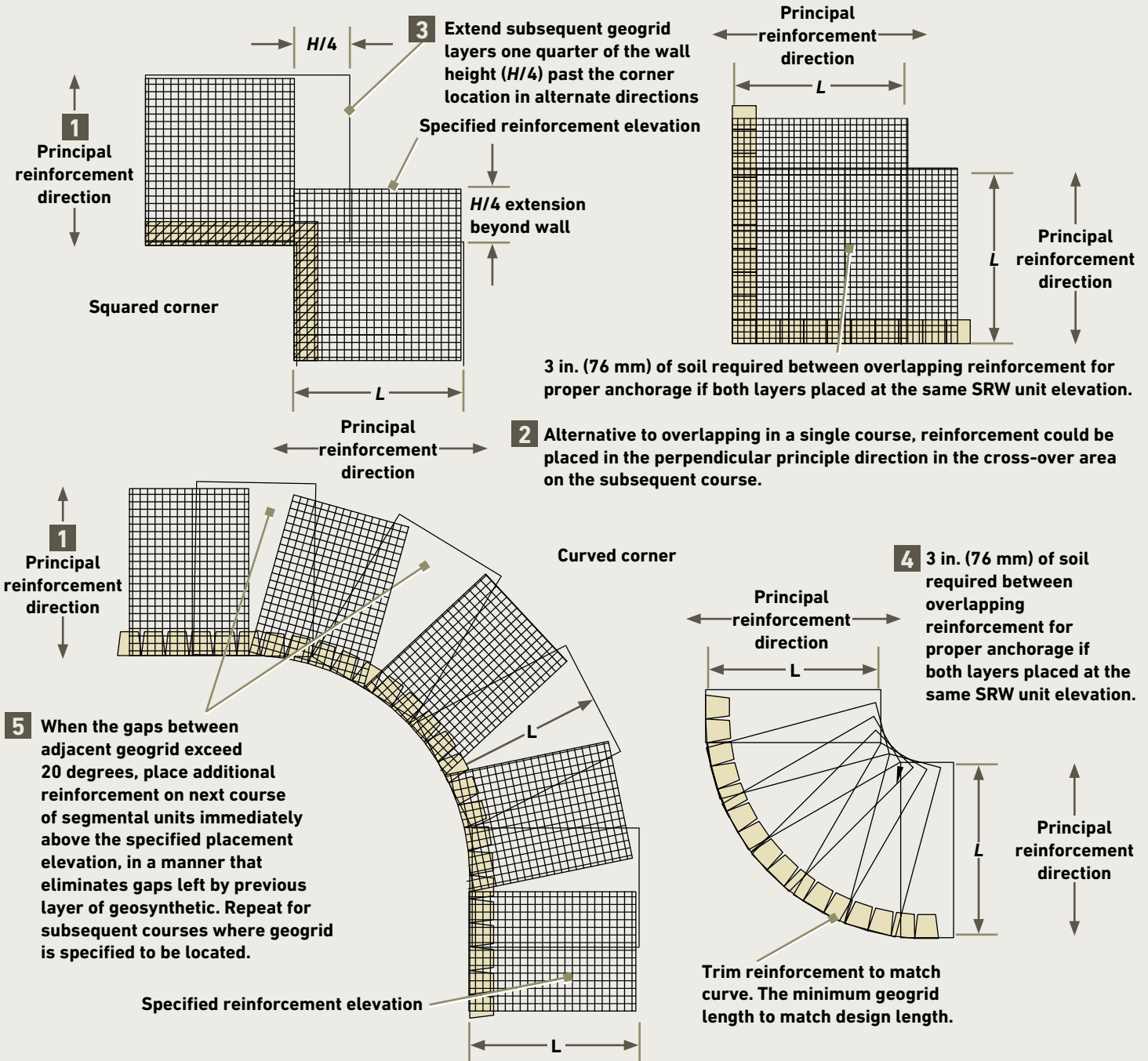

Figure 6 | Geosynthetic Reinforcement Layout

- 1** Typical commercial geogrid is strong in the roll direction and placed perpendicular to the wall facing.
- 2** Stagger geogrid layers on alternate sides, weaving layers to avoid overlap.
- 3** Extend geogrid layer into the corner from one side equal to 25% of the total wall height.
- 4** Where geogrid tails overlap naturally, place 3 in. (76 mm) of rock or soil between the overlapping layers.
- 5** When geogrid fans apart, place a secondary, equal length layer of geogrid on the next course above to span the gap.

6.1 GENERAL

Section 2.2 includes general recommendations for the minimum properties and quality control characteristics of geosynthetic materials. Key considerations for the installation of geogrid include:

- Type, number of layers, layer length, and layer elevations clearly noted on the drawings or in the contract documents.
- The minimum length of geogrid is 60% of the total wall height, H, but not less than 4 feet (1.2 m). Reinforcement lengths are measured from the front face of the wall.
- See Table 1.3-2 for geogrid spacing recommendations.
- The first layer of geosynthetic reinforcement should be placed on top of the first or second course of block. Refer to Figure 1 for detailing.
- Place a minimum of 6 inches (152 mm) of backfill before operating tracked equipment on top of reinforcement.

- When structures interfere with the reinforcement installation, they must be addressed with site-specific details.
- No substitution in geogrid is allowed without approval by the design engineer.
- Any change to specified materials should be evaluated by the SRW design engineer and may require a redesign of the wall.

6.1.1 Proper Orientation of Geogrid and Placement

- Cut geosynthetic reinforcement to design length (L) as shown on the plans and install with design strength direction perpendicular to the wall face. Bring geosynthetic to the front of the block and secure following manufacturer's details with the upper block. Typically the geogrid should extend to no less than 1 in. (203 mm) from the face of the wall.
- For straight walls, placement of adjacent sheets of reinforcement should be side-by-side without any overlap.

- For walls with corners or curves as shown in Figure 6, the following are the recommended practices for geogrid placement:
 - For outside corners, to avoid overlapping geogrid layers, geogrids should be staggered by one course on either side of the corner, weaving the strong direction from bottom to top of wall.
 - For inside corners, extend the geogrid layer into the corner from one side a distance equal to 25% of the total wall height. Alternate extended geogrid layer from side to side per course to create a geogrid weave as the wall is built.
 - For outside curves, where geogrid tails overlap naturally, place roughly 3 inch (75 mm) of gravel fill or reinforced soil between the overlapping layers.
 - For inside curves, where geogrid layers fan apart and the gap angle exceeds 20 degrees, place a secondary, equal length, layer of geogrid on the next course above the fanned gap.

7.1 OVERVIEW

In the project specifications, establish inspection and testing requirements in advance of providing a wall design. While quality control is generally considered to be the responsibility of the wall contractor, quality assurance is the responsibility of the owner. The owner should retain the services of an independent testing and inspection firm to provide quality assurance for the project, which may also be the project geotechnical engineering company.

7.2 SOIL INSPECTION AND TESTING

The project geotechnical engineer, retained by the owner, should verify and document that all soils available for use for wall construction meet those specified in the soils report and correspond to those assumed for the design of the wall. Inspection and testing requirements should be established through the project specifications in advance of providing a wall design. The owner should retain the services of an independent testing and inspection firm to provide quality assurance for the project, which may also provide the geotechnical engineering services for the project. Additional considerations include:

- Independent firm to keep testing and inspection log and provide written reports at predetermined intervals to the owner.
- Size and scope of project will require different levels of testing and inspection.
- Testing frequency for compaction effort should be defined to establish

a proper compaction protocol to consistently achieve the minimum specified compaction set by the design requirements. If full time inspection and testing is not provided, then the following testing frequency should be followed:

- One test for each soil lift, (not exceeding 8 in. (203 mm)) but not less than one test for every 50 cubic yards (38 cubic meters) of compacted fill at a spacing not to exceed 100 ft (30 m).
- Vary compaction test locations to cover the entire reinforced zone; including the area compacted by the hand-operated compaction equipment behind the wall. If the required compaction behind the wall cannot be achieved using hand-operated equipment or by reducing lift heights, the entire zone should be replaced with gravel fill material.
- Once protocol is deemed acceptable, testing can be conducted randomly at locations and frequencies determined by the testing firm and approved by the SRW design engineer.
- Slopes above the wall must be compacted and checked in a similar manner.
- Gradation and plasticity index testing should be conducted at the rate of 1 test per 2000 cubic yards (1500 cubic meters) of material placed or when the appearance or behavior of the soil change noticeably.

- The maximum soil lift height should not exceed 8 in. (203 mm) following compaction. No more than a single course of SRW units should be placed prior to placing fill material.

7.3 SRW UNITS

See Section 2.1.2 for recommendations for the sampling and testing of SRW units.

7.4 GEOSYNTHETIC REINFORCEMENT

Prior to the start of construction, geosynthetic manufacturer's certificates (See Section 2.2) should be provided and certify the material(s) meet the product style designation(s) and minimum ultimate tensile strength(s) for the product style indicated on the approved shop drawings. Where necessary, the manufacturer should provide certification of geosynthetic raw materials (e.g. resin, PET fiber) as required by specification.

Determination of geosynthetic reinforcement long-term design strength and associated material reduction factors needs to be evaluated by the SRW design engineer accounting for the product specific reduction factors (e.g. creep, durability, installation damage) associated with the designated geosynthetic reinforcement considered in the design. The SRW design engineer is responsible for determination of the reinforcement LTDS (long-term design strength) and approval of geosynthetic supplier.

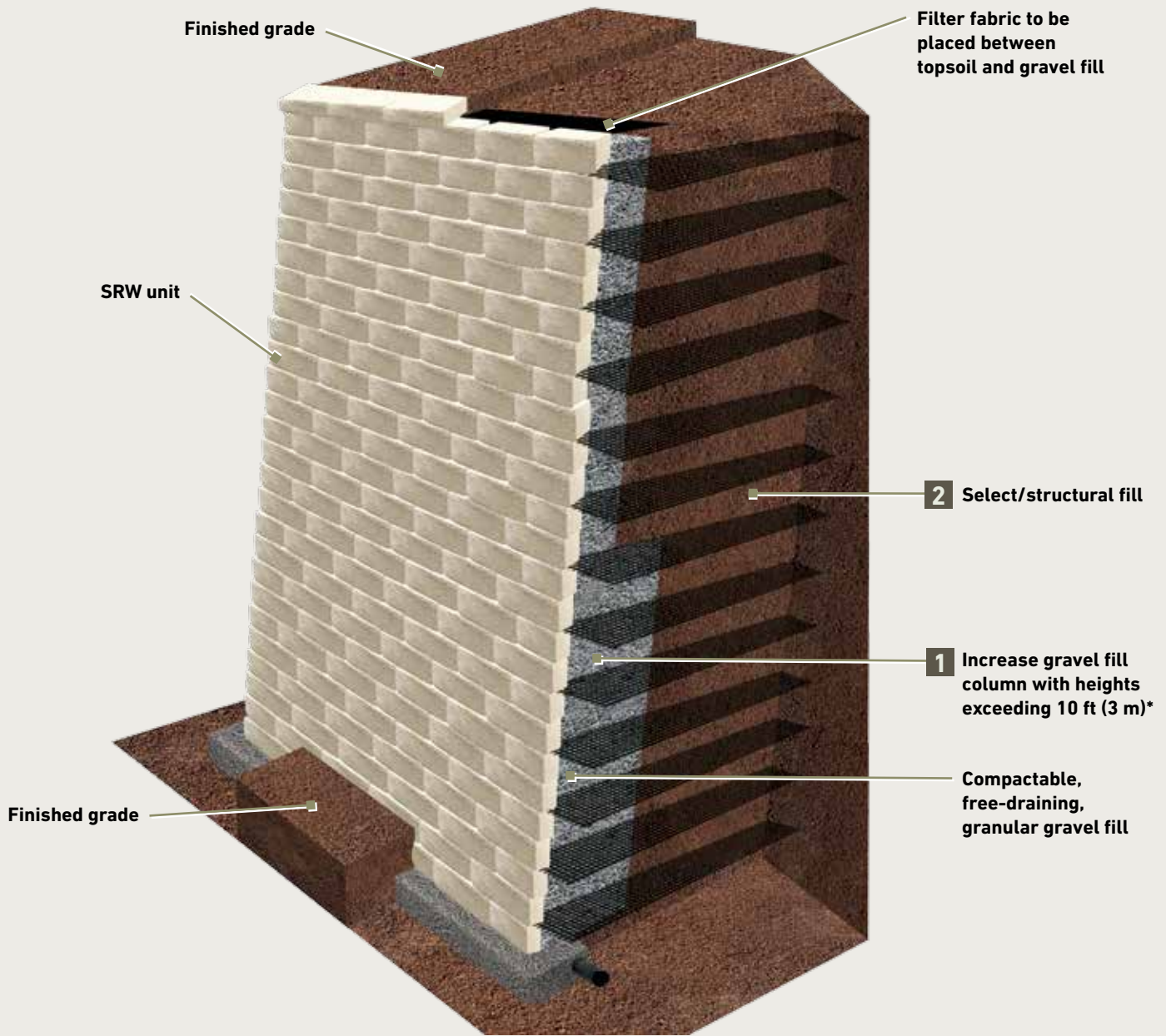

Figure 8 | Tall Walls

- 1** See Section 8.1.3 for gravel fill thickness requirements at the face of the wall.
- 2** See Section 8.1.1 for recommended use of select/structural fill for tall walls. See Section 8.1.2 for compaction recommendations for tall walls.

**To simplify construction, it is also permitted to maintain the thicker gravel fill used at the base of the wall over the entire wall height.*

Chapter Summary

In general, the taller the SRW the less forgiving it will be to shortcuts taken during its design or construction. Because of their critical nature and size, tall walls require better soils, more rigorous attention to quality control and quality assurance, closer scrutiny to potential settlement, greater attention to compaction efforts during construction, and careful attention to detailing and the overall impact on the project site.

8.1 TALL WALLS

Taller walls, walls in excess of 10 feet (3 m), will influence a much larger portion of the site than smaller walls. Project design professional(s) must pay careful attention to site conditions well beyond the location of the SRW wall face and well below the SRW system. Layout considerations, such as the wall batter and geosynthetic reinforcement lengths become more significant with tall walls.

The Project Site Civil engineer must carefully review the site geometry and existing or new structures above and below the wall to adequately plan for the use of the land placed into service by the retaining wall structure. Careful attention needs to be paid to property boundaries and the extent of the required excavation.

The following strategies are recommended to address the structural concerns associated with taller walls.

8.1.1 Select Granular Backfill

As previously discussed in the soils section of this document, as walls become taller, higher quality soil should be used in the entire reinforced zone. For walls between 10 and 20 feet (3 and 6 m) in height, the gradation recommendations of Table 3.3-1 may continue to be used as long as the plasticity index (PI) of the material is less than 6. For walls in excess of 20 feet (6 m), the gradation requirements of Table 8.1.1-1 are recommended.

There may be instances where the use of select granular backfill within the entire reinforced zone is not feasible or inappropriate. For example, this can occur where there are concerns with respect to differential subgrade behavior. See recommendations in Section 3.3 for guidance on the use of layering different soils within the reinforced zone.

8.1.2 Compaction Requirements

As the wall height increases, elastic compression of the fill material becomes a concern and as such the compaction requirements may need to be increased to a minimum of 95 percent Modified Proctor density or 98 percent Standard Proctor density as directed by the project geotechnical engineer or wall design engineer. Moisture control should be as previously discussed in Chapter 3.

8.1.3 Gravel Fill at the Face

As walls increase in height, the wall designer needs to expand the depth of the gravel fill used at the face of the wall. Increasing the minimum depth of the gravel fill behind the SRW unit face up to 3 ft (0.9 m) is used to assist in graduating any differential settlement between the wall units and the reinforced backfill soils.

- For walls up to 10 ft (3 m) tall, use a minimum of 12 in. (305 mm) of gravel behind the wall unit, but not less than a minimum of 24 inches (610 mm) from the face of the wall.
- For walls greater than 10 ft (3 m) in height but less than 20 ft (6 m), increase the minimum width of gravel for the bottom 10 ft (3 m) of the wall to 24 in. (610 mm), but not less than a minimum of 36 in. (914 mm) from the face of the wall depending upon the depth of the SRW unit.
- For walls greater than 20 ft (6 m) the lower portions should have 36 in. (914 mm) of gravel fill thickness measured from the back face of the wall (48 in. (1219 mm) measured from the front face of the wall). The gravel fill thickness for the top 10 ft (3 m) and top 10 to 20 ft (3 to 6 m) should be as previously discussed. For ease of construction, it may be appropriate to establish an elevation where all gravel fill is of a consistent depth.

8.1.4 Quality Control, Quality Assurance

The SRW construction plans should include detailed requirements for onsite inspection prepared by the SRW design engineer to ensure that specifications are complied with during construction. The testing and inspection firm retained by the geotechnical engineer or owner needs to evaluate conditions prior to construction and then document the construction process. This includes, but is not limited to:

Table 8.1.1-1 | NCMA Reinforced Fill Gradation for Tall Walls (> 20 ft (6 m))

Sieve Size	Percent Passing
1 in. (24 mm)	100 ¹
No. 4	100-20
No. 40	0-60
No. 200	0-15 with PI < 6

¹Larger aggregate size can be considered if the geosynthetic reinforcement has been assessed for full-scale installation damage testing using similarly graded backfill.

- Confirmation that the foundation soils are suitable for support of the structure.
- Confirmation that the retained soils are as defined in the wall design.
- Verify the reinforced soils comply with the material specified in the wall design.
- Confirm geogrid reinforcement is as specified in the wall design.
- Verify the wall unit is as specified in the wall design.
- Document the construction process, verifying the wall is constructed in general accordance to the plans and specification.
- Perform the required soil testing in order to evaluate/validate that the soil placed meets the specified gradation, shear strengths, weight, Atterberg limits and compaction requirements.
- A detailed construction log should be used with sign offs at incremental levels by the responsible parties.

8.2 SRW UNIT HEIGHT TOLERANCES

Although the construction of any dry-stack system should consider the impact of varying unit height tolerances, the concerns are largely mitigated for walls of relatively short height. For tall walls, however, the SRW design engineer should take into consideration the recommendations of this Guide and consult with the SRW installer and producer to convey the performance objectives for the project and align them with expectations regarding both unit height tolerances as well as final wall tolerances.

When considering the impact of varying height dimensions on SRW construction,

however, the critical factors to consider include not only how the height profile of an individual unit varies, but how the heights of units vary relative to each other. Impacts to consider include:

- **Absolute Height** – If every unit used on a project is produced to the exact same height, regardless of the absolute deviation from permitted tolerances, there is no impact to the constructability or performance of the system once in service. For example, if every unit on a project was produced $\frac{3}{16}$ in. (4 mm) shorter than the specified height, which is technically out of tolerance, there would be no impact to the strength, serviceability, installer productivity, or finished aesthetics of the system. On very tall wall applications, however, there would need to be an additional course or courses of units added (possibly with additional layer(s) of geogrid) to the top to make up the cumulative height shortage.
- **Batter** – If the back of an SRW unit is higher or lower than specified relative to the front of the unit, the successive stacking of courses can begin to impact the wall's batter. If the back of the unit is lower than the front, the net result will effectively lean the batter into the reinforced zone and increase the stability of the system. If, however, the front of the unit is lower the batter will begin to push outward away from the wall. Each of these potential issues, however, are primarily a concern with taller walls where the slight batter changes from course-to-course accumulate. To maintain the stability and performance of the system, the batter construction tolerances reviewed in Section 5.10 should be adhered to by shimming

units where needed; particularly for taller walls.

- **Unit-to-Unit Variation** – If two adjacent units have different heights, either resulting from one or both units having heights that differ from one side of the unit to the other or the absolute height of one unit being different than the adjacent unit, the recommended maximum height difference between adjacent units should not exceed $\frac{1}{8}$ inch (3 mm).
- **Construction Productivity** – The speed in which SRW units are installed is directly impacted by height consistency of the units. If contractors need to periodically shim between courses of units or adjust unit placement, construction productivity can decrease.

8.3 CRACKING

If the bearing surfaces of the units are not uniformly supported, the units may crack between points of support. This is most commonly seen in tall walls where the bottom courses of units are carrying a substantial surcharge load from the self-weight of the units above. While this cracking may present an aesthetic distraction, it does not compromise the structural stability of the system. Further, the cracking may actually help to redistribute the stresses at the wall face for increased system stability. Unless specified otherwise, the general industry practice allows a relatively small percentage of the units within an assembly to be cracked. When cracking is in question, have the SRW design engineer conduct a site assessment to identify the cause of the cracking and determine whether remediation is necessary. In no case, however, should the gap between units exceed one-half of the nominal gravel fill size.

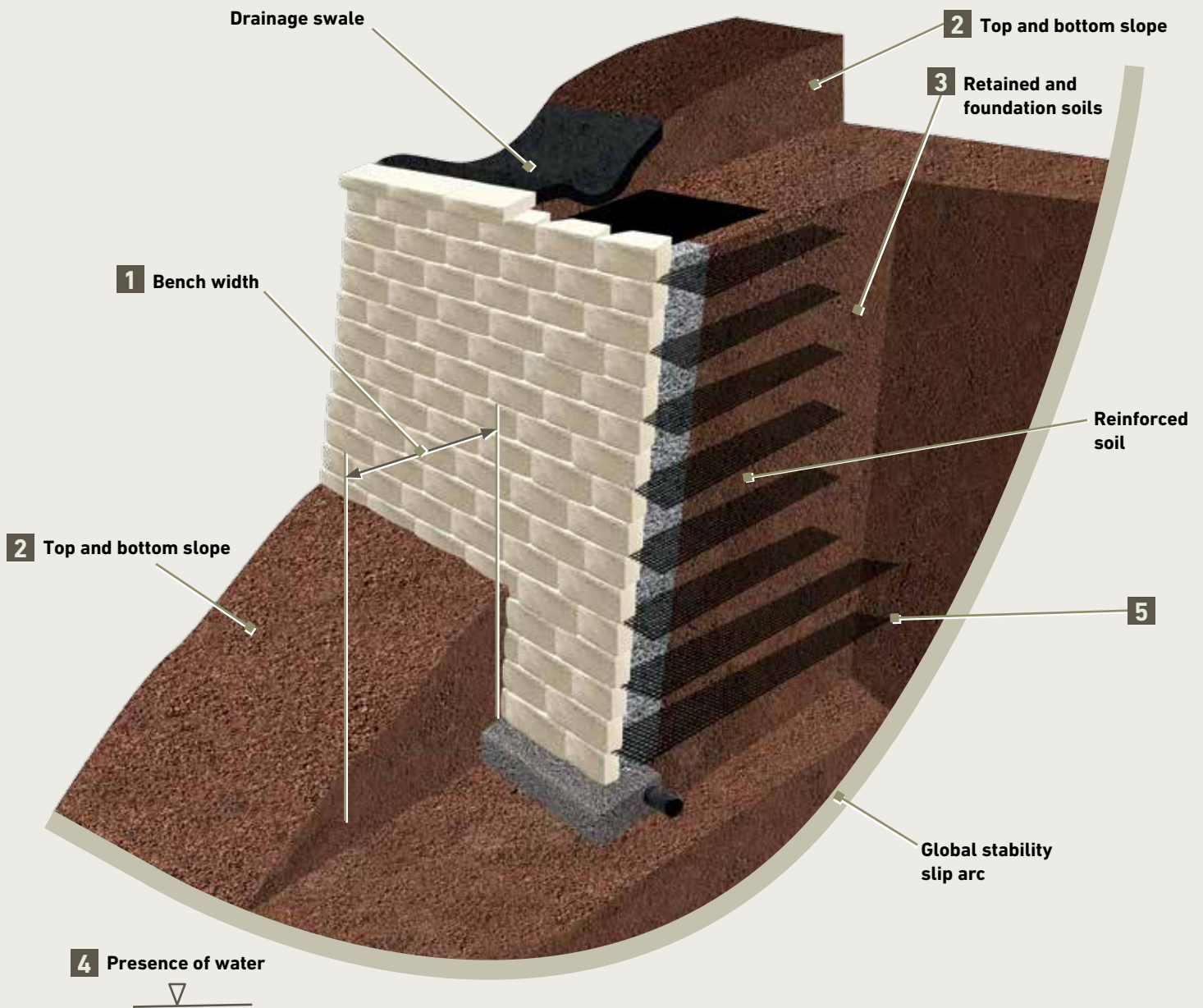

Figure 9 | Global Stability

- 1** Walls with slopes below require increased embedment and enough soil in the front to ensure stability. See Section 9.1.1.
- 2** Walls with slopes above or below require global stability analysis (Section 9.1.2)
- 3** Walls built in sites with clay, silt, poorly graded sand, or expansive clays require global stability analysis (Section 9.1.2)
- 4** Walls with shallow ground water or water at the wall face require global stability analysis
- 5** To increase global stability (or internal compound stability), increase geogrid length, geogrid strength, and/or depth of embedment (Section 9.1.3)

9.1 GENERAL

A geotechnical engineer familiar with the site should either check global stability or coordinate with the SRW design engineer if the SRW design engineer is performing global analysis checks.

9.1.1 Wall Embedment with Toe Slope

Wall embedment depth should be determined by the wall design engineer in coordination with the site civil engineer in coordination with the site civil engineer based on typical industry recommendations (see Figure 1.3-1) and specific site requirements.

- Walls with slopes below must have additional buried course(s). Embedment should comply with Figure 1.3-1.
- In general when a slope below the wall is present, there is need for a global stability analysis to confirm the overall stability of the site.

9.1.2 When to Analyze Global Stability

If a global stability analysis is not included in the SRW design engineer's scope of work, establish that when a global stability analysis is required by the wall designer, using their best engineering judgment, then the owner will contract with a geotechnical

engineer for overall site stability. Global stability analysis should be run for a variety of conditions including:

- For those walls with slopes below or above the retaining wall.
- Mid-slope walls, particularly those with slopes above and below, are problematic and may require additional reinforcement and a more thorough analysis.
- Walls built on sites with clays, silts, or expansive clays.
- When foundation soils are soft or weak.
- For walls where more than 50% of the Internal Compound Stability (ICS) slip arcs converge at the back of the wall design envelope.
- When the wall or toe slope is partially or completely submerged or when shallow ground water conditions exist.
- Tiered walls; as discussed in Chapter 10.
- Global stability analysis should include not just the tallest wall sections but also intermediate locations where critical combinations of walls and slopes exist.

9.1.3 Increase Global Stability Options

Ways to mitigate potential global stability concerns include:

- Increasing the length of the geosynthetic reinforcement layers to force the minimum slip arcs deeper into the hillside.
- Increasing the strength of the geosynthetic reinforcement layers to force the minimum slip arcs outside the reinforced zone.
- Increasing the wall embedment depth to force the minimum slip arcs deeper into the hillside.
- If the cause for the global stability problems is weak foundation soils, it may be necessary for the geotechnical engineer on the project to do foundation improvements before the retaining wall is built.
- Using a higher quality backfill increases the friction angle and shear strength of the reinforced soil, which in turn increases stability.
- Where present, slopes may also be reinforced to intersect slip arcs and increase the global stability factor of safety.

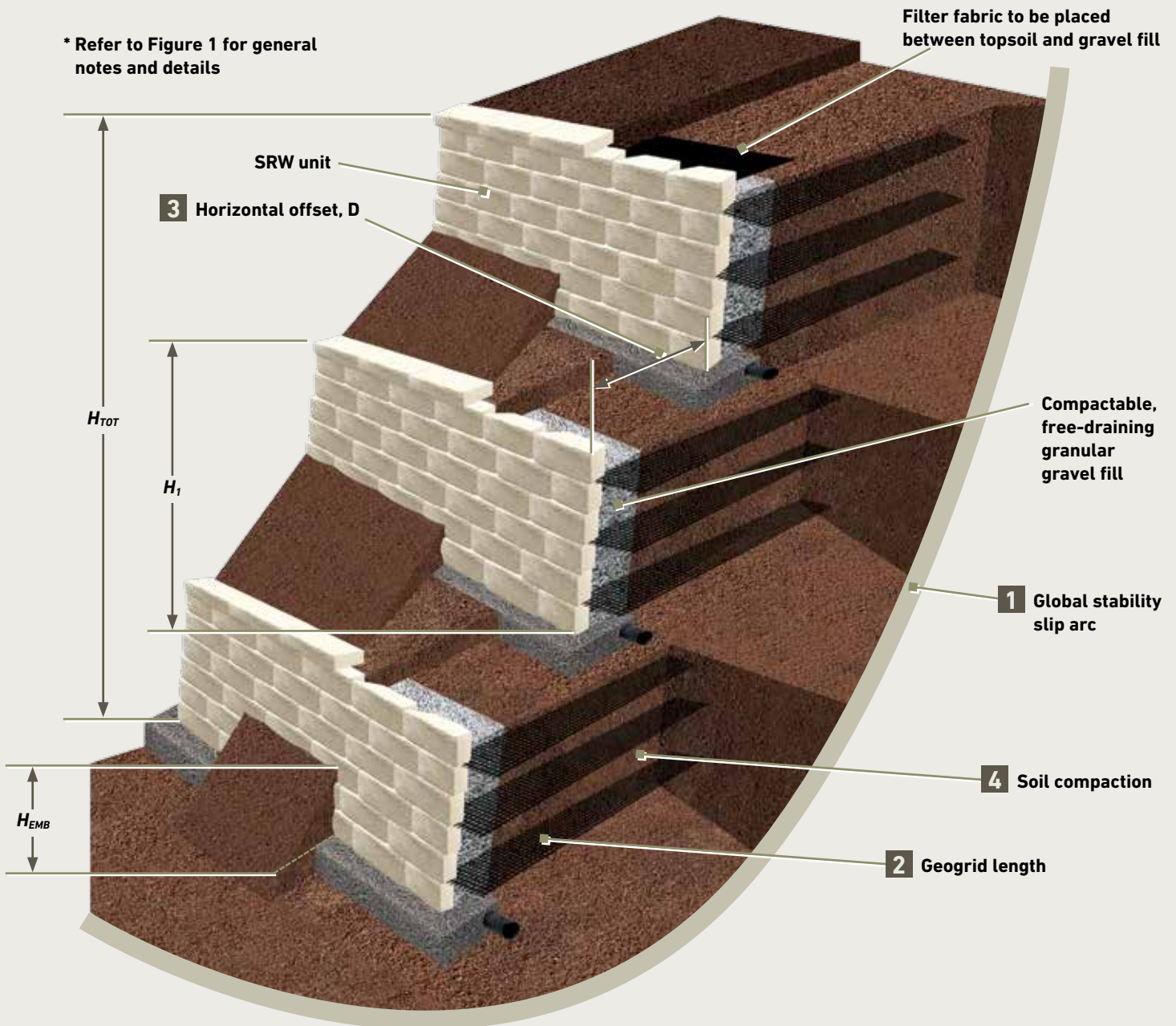

Figure 10 | Terraced Walls

- 1** Whenever walls are constructed in a terraced arrangement, the design must consider the overall global stability of the structure.
- 2** In a terraced structure geogrid lengths for the bottom terrace are typically 60% (min.) of the entire height (H_{TOT}). A global analysis will dictate overall geogrid lengths.
- 3** Walls closer than $2H_1$ (H_1 = height of the tier below) horizontally should be evaluated as an added surcharge to the terrace below.
- 4** Proper compaction is necessary for foundation soils, reinforced soils, and gravel fill below each tier to limit settlement.

10.1 TIERED OR TERRACED WALLS

Tiered walls often require more complex analysis than provided by standard wall stability design methods. Some simpler cases, however, may be conservatively modeled by the following method.

- The effect of the upper tier walls is to act as a uniformly distributed load on the underlying tiers. If a tiered retaining wall is placed within a horizontal distance (wall face to wall face) less than twice the height of the underlying wall ($D < 2H_1$), a load will be applied to the lower wall. This 2V:1H rule assumes that there are no slopes below, between or above the tiered structures and that there are reasonably competent soils.

Additional information on the design of tiered walls is provided in *Design Manual for Segmental Retaining Walls* (Ref. 1).

- It is common to have the design geosynthetic reinforcement lengths for the bottom terrace equal to at least 60% of the total terraced structure height as a design starting point. Final design generally has geogrids longer than 60% and may be more than 100% of the total vertical grade change.
- Subsequent terraces above would use similar rationale to determine their minimum geogrid lengths.
- If the upper tier is setback past the reinforced zone of the lower wall, however, it may behave more like a live load than a dead load because

the vertical load of the upper wall is not contributing to stabilizing forces in the lower wall.

- Greater attention to compaction should be placed on the foundation soils below the upper terraces and in transition areas where the wall splits from one wall into two. If the soils are not properly compacted in these areas, settlement can occur over time that could cause aesthetic concerns.

Whenever walls are constructed in a terraced arrangement, or any of the other conditions listed, the designer must consider the overall global stability of the system. See Chapter 9.

* Refer to Figure 1 for general notes and details

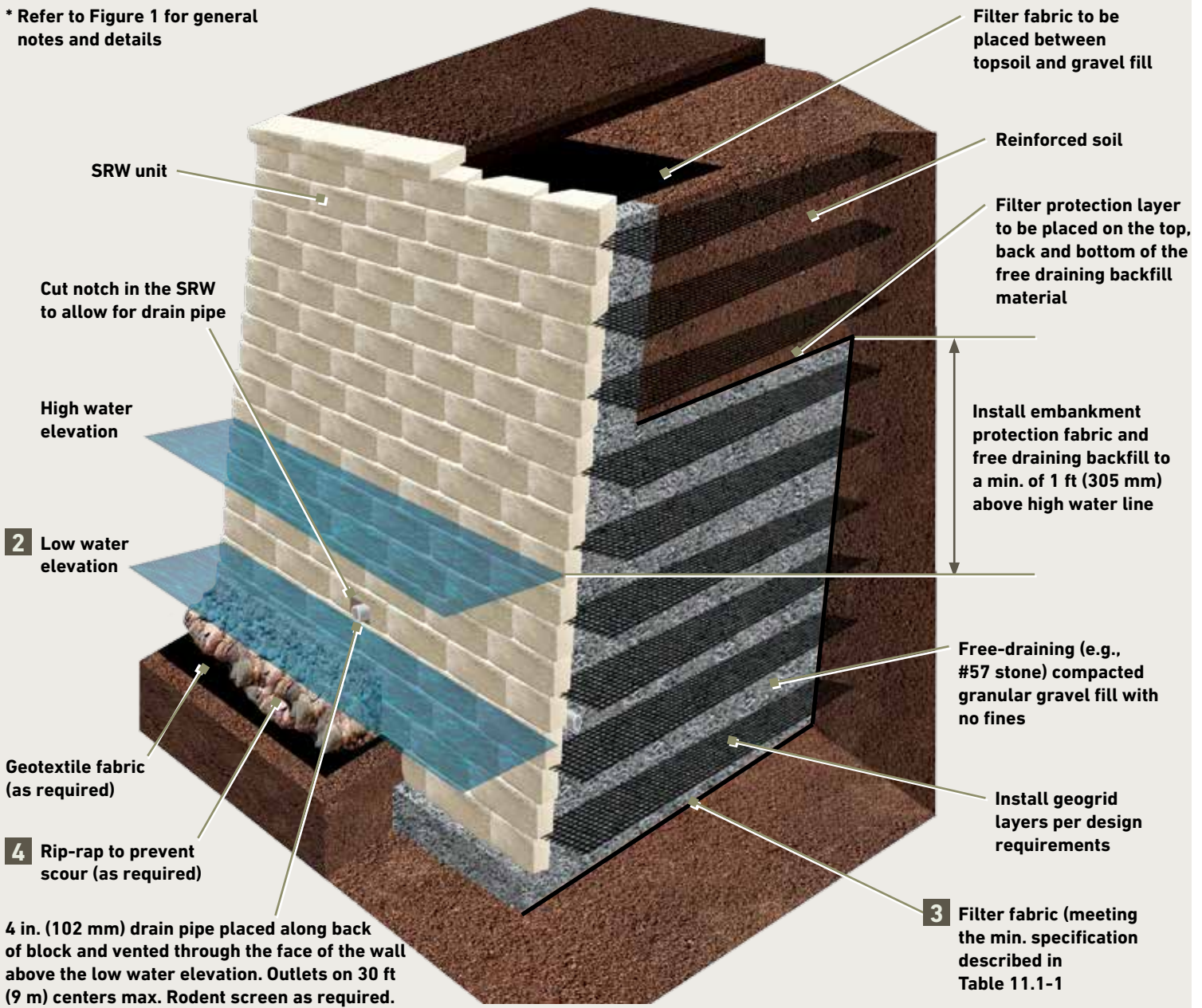

4 in. (102 mm) drain pipe placed along back of block and vented through the face of the wall above the low water elevation. Outlets on 30 ft (9 m) centers max. Rodent screen as required.

Figure 11 | Water Applications

- 1** Free-draining backfill placed to the limits of the geogrid up to a height of at least 12 in. (305 mm) higher than any water source.
- 2** Drain pipe raised to the low water elevation to aid in evacuation of water during water fluctuation.
- 3** Filter fabric should be used to encapsulate the reinforced mass.
- 4** When moving water is present or anticipated, geotextile and rip-rap should be placed in front of the wall should be placed to protect the wall from scour effects as determined by the site civil engineer. The embedment depth should be extended to the anticipated scour depth.

11.1 WATER APPLICATIONS

When more than incidental groundwater is known to move through the retained soils, gravel fill or free-draining fill should be placed to the limits of the geosynthetic reinforcement lengths up to a height equal to 12 in. (305 mm) higher than the water source.

When a retaining wall is to be part of a water application such as in a lake, stream or detention basin, the following additional recommendations should be considered.

- The gravel fill or free-draining fill should be placed to the limits of the geosynthetic reinforcement lengths up to a height equal to 12 in. (305 mm) higher than the determined high water mark. If the high water mark is unknown, the entire reinforced zone should be constructed with a free-draining fill. This may be relaxed for conditions where the reinforced zone drains at least as fast as the water level drops in front of the wall.
- The drain pipe should be raised to the low water elevation to aid in the evacuation of water from the reinforced mass as water level fluctuates.

- Filter fabric should be used along the bottom, back, and top of the reinforced mass to a height of 12 in. (305 mm) higher than the determined high water mark. This fabric should not be prone to clogging due to the presence of fines in the native (retained) soil
- Filter fabric is also used between rip rap and foundation soils in water applications. For the filter fabric below the rip-rap, consideration should be given to using a high strength polypropylene monofilament material designed to meet or exceed typical NTPEP specifications; stabilized against ultraviolet (UV) degradation and typically meets or exceeds the values in Table 11.1-1. Such material is particularly resistant to clogging.
- For walls having moving water or wave action, place rip-rap in front of the wall to protect the toe of the wall from scour effects. The need for rip-rap is typically determined by the site civil engineer.
- When water features adjacent to the wall are subject to freezing, additional considerations include the potential for impact and expansive forces on the wall.
- The presence of water in the foundation soils reduces the effective stress and thus can be destabilizing. Global stability analysis is recommended in such situations.

Table 11.1-1 | Embankment Protection Fabric Specification

Mechanical Properties	Determination Properties
Tensile Strength = 225 lb/in. (39.4 kN/m)	ASTM D4595
Puncture Strength = 950 lb (4228 N)	ASTM D6241
Apparent Opening Size (AOS) = U.S. Sieve #70 (0.212 mm)	ASTM4751
Trapezoidal Tear = 100 lb (445 N)	ASTM D4533
Percent Open Area 4%	COE - 02215
Permeability = 0.01 cm.sec	ASTM D4491

* Refer to Figure 1 for general notes and details

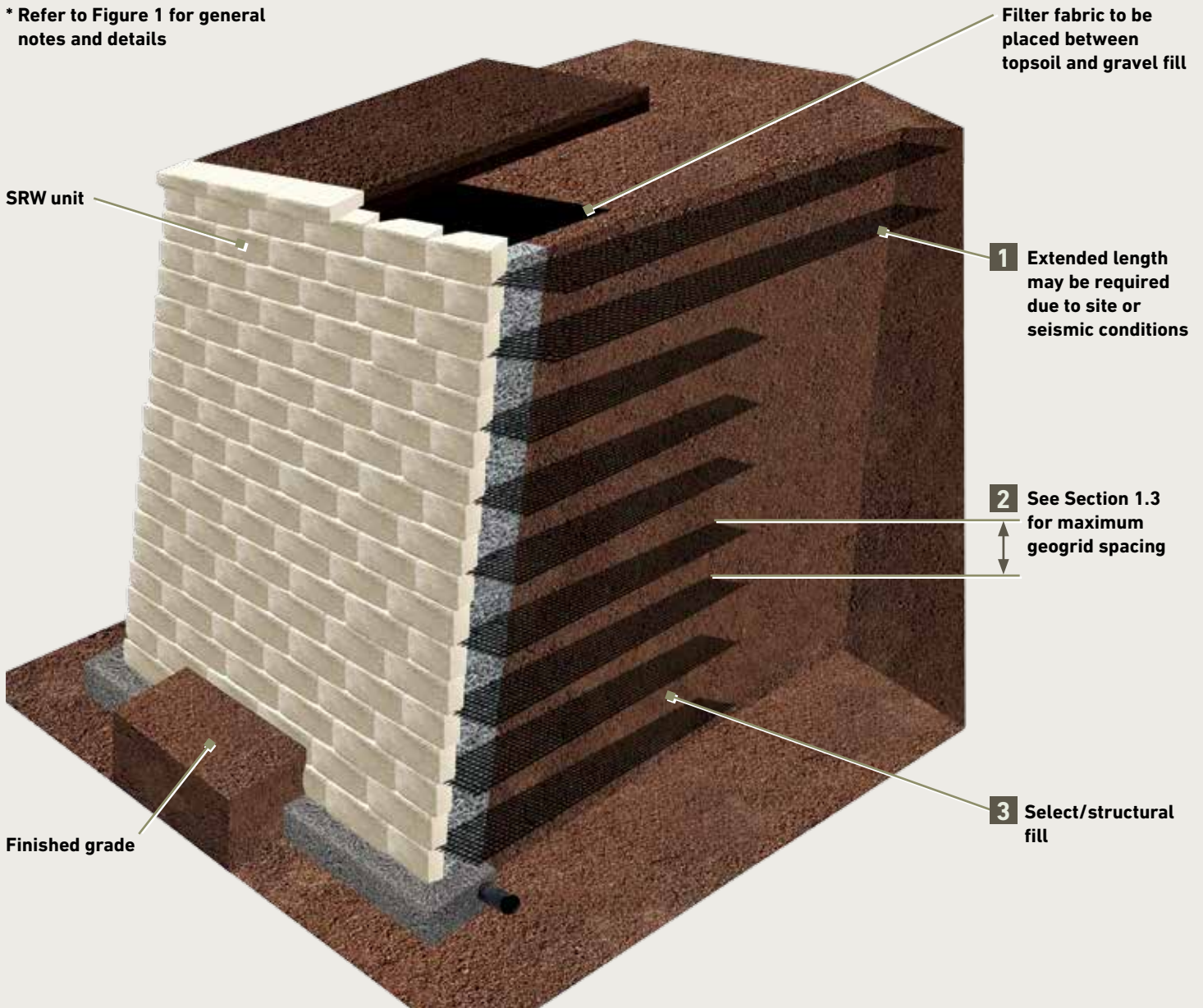

Figure 12 | Seismic Considerations

- 1** Typically the top layer(s) of geogrid will be extended for seismic loading to mitigate soil cracking at the reinforced/retained soil interface. See Table 1.3-1.
- 2** See Section 1.3 for maximum geogrid spacing under seismic conditions.
- 3** Using select backfill will reduce the effects of the dynamic loading. See Table 8.1.1-1.

12.1 SEISMIC CONSIDERATIONS

The SRW design engineer must understand the local seismic code requirements before starting design.

For walls with dynamic loading where the seismically-induced peak ground acceleration (PGA) is greater than 0.18 g (for walls with 4:1 or flatter backslopes) or PGA greater than 0.15 g (for walls with backslopes steeper than 4:1) the following recommendations should be considered:

- Closer spacing of geosynthetic reinforcement may be required by design, a maximum 16 in. (406 mm) is recommended.
- Extend the top layers of geosynthetic reinforcement. Typically the top layers will be extended to roughly 90% or more of the wall height to satisfy design requirements. See Table 1.3-1.
- Using select/structural backfill will reduce the effects of the dynamic loading.

- In seismically active areas with any type of loading above the wall, including slopes and surcharges, consideration should be given to increasing the length of the upper geogrid layer(s) to 90% of the wall height or an additional 3 ft (0.9 m), whichever is greater. In the event that other objects interfere with the top layer extension, it is acceptable to move this extended layer to a lower geosynthetic reinforcement elevation at the top of the structure.
- Minimum factors of safety used in design need to be adjusted per Table 1.3-1.
- The owner's geotechnical engineer provides the seismic design parameters for the design of the walls.

For more information on seismic design and the effects on segmental retaining walls, see NCMA *Design Manual for Segmental Retaining Walls* (Ref. 1).

When dealing with a slope above a wall with seismic loading applied to the wall, the same acceleration coefficient applied to the wall must also be applied to the stability calculations of the slope.

The Mononobe-Okabe (M-O) seismic methodology places limits on the steepness of any slope above the wall while still maintaining acceptable factors of safety. If during the design phase it is determined that the desired slope is not allowed, the wall designer should:

1. Contact the site civil engineer to propose altering the site grading or increasing the wall height to reduce the steepness of the slope above. Additional design guidance for SRWs subjected to large seismic loading is provided in TEK 15-9B (Ref. 16).
2. Investigate the use of a more rigorous analysis method than provided by the NCMA design manual (Ref. 1) such as trial wedge, finite element, or other.

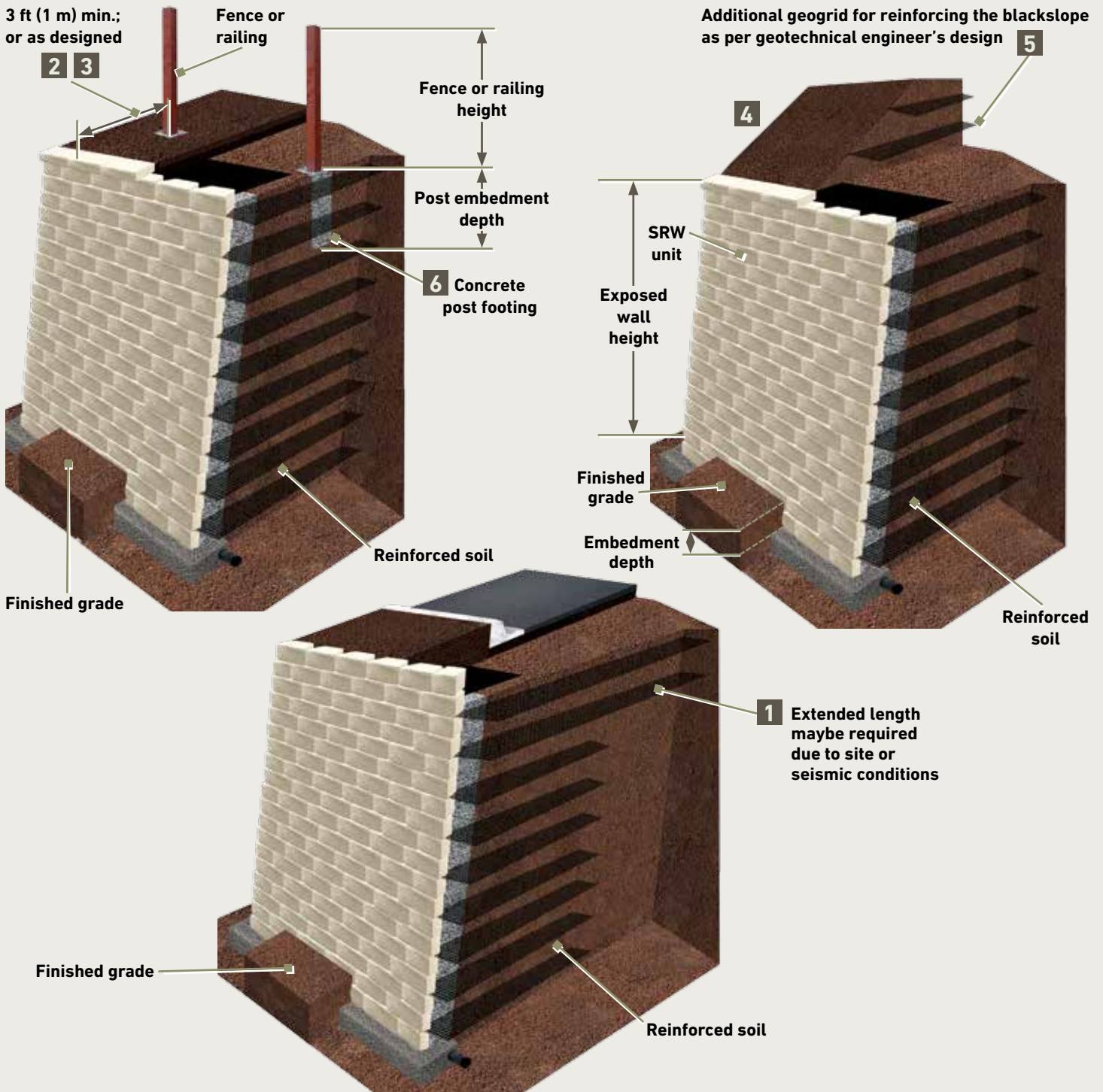

Figure 13 | Above Wall Considerations

- 1** Geogrid length may need to be extended to address pullout or seismic design (Section 13.1.1).
- 2** Structures should be positioned 3 ft (1 m) behind the top course, or as designed, to accommodate localized overturning design (Section 13.1.2).
- 3** When fence posts are within 3 ft (1 m) of the wall face, the SRW design engineer should consider the local overturning forces applied to the wall facing (Section 13.1.2).
- 4** Proper lift thickness and compaction of slope should follow geotechnical recommendations.
- 5** Reinforce backslopes per geotechnical engineer's design (Section 13.1.4).
- 6** Column tube or pvc pipe to be installed during wall construction. Alternatively, post footings will require hand excavation following construction to prevent geogrid damage.

13.1 ABOVE THE WALL CONSIDERATIONS

13.1.1 Minimum Geogrid Lengths at the Top of the Wall

- Top layer of geogrid can be longer than the grids below to address pullout.
- In seismically active areas, the geogrid length may need to be extended up to 90% of the wall height or 3 ft (1 m), whichever is greater.
- The portion of wall above the top layer of geogrid should be reviewed as a gravity wall taking into account all soil parameters and surcharge loads.

13.1.2 Fences and Railings

- Impact structures or fence posts should be positioned a minimum of 3 ft (1 m) from the face of the top course to accommodate designing for localized overturning forces.
- If fence posts must be placed within 3 ft (1 m) of the wall facing, the designer must consider the localized top-of-wall overturning force in their design.
- Common lateral loads from railings are 50 lb/ft (0.74 kN/m) along the top of the railing or 200 lb (0.9 kN) point load at the top of the post, or both depending on the local requirements.
- Common post footings are formed by using construction tubes placed at desired locations during

construction. If posts are placed after construction is complete, holes must be hand dug as using a power auger may cause severe damage to the geosynthetic reinforcement layers depending upon the grid type and confining stress.

13.1.3 Traffic Barriers and Guide Rails

For walls that will support traffic, appropriate protection should be provided to protect traffic. Vehicle protection should consider:

- Use of a post guiderail for moderate speed traffic (i.e., less than 25mph), with the back of the guiderail post offset a minimum of 3 ft (1 m) from the front of the SRW units. AASHTO requirements include: 3 ft (1 m) offset from the wall face with a minimum post depth of 5 ft (1.5 m). The top two layers of geogrid must each be designed for an additional 150 lb (667 N) force.
- For parking lots and drive aisles, guiderail should be provided where geometry dictates an increased likelihood of vehicular impact with the wall.
- Vehicle barriers should be required for wall heights greater than 10 ft (3 m) that are adjacent to roadways or parking lots. Design of vehicle barriers will likely result in the need for moment slabs to resist vehicular impact as the SRW provides nominal lateral resistance in comparison to vehicular impact loads.

13.1.4 Slopes Above the Wall

Slopes above the wall are required to be compacted following the proper lift and compaction recommendation from the geotechnical recommendations. Depending upon project requirements, some slopes may require reinforcement.

Geogrid may be used in the slopes above the retaining wall to increase the stability of the slope due to steepness, soil type, and seismic loads. The recommendation will need to come from the geotechnical engineer on the project.

13.1.5 Landscaping

In general, plantings in the reinforced zone are acceptable and reduce the risk for erosion provided:

- Engineer should review with the owner the planting plans from the landscape architect to verify size of root balls and if any geogrid reinforcement layers will be disrupted.
- As appropriate, language should be placed in the project specifications addressing the use of landscaping within the reinforced zone.
- Augers should never be used within the reinforced geogrid zone.
- The landscaping must be completed as soon as the wall is finished.
- The potential impact of excessive irrigation should be taken into consideration during design.

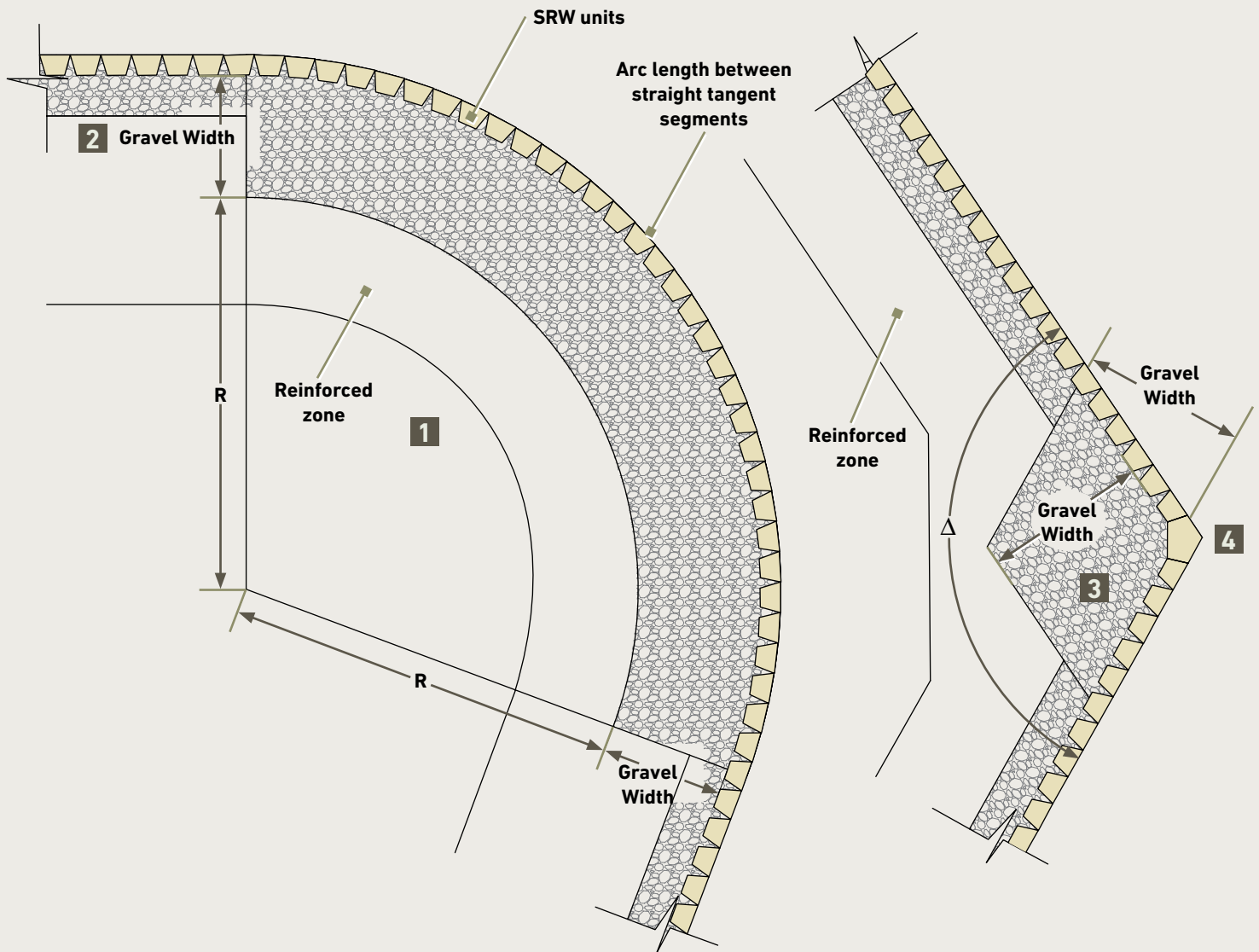

Figure 14 | Gravel Width Placement on Curves and Corners

- 1** Geogrid is not shown for clarity. See Figure 6 for the installation of geogrid at corners and radii.
- 2** For outside curves, increase the thickness of the gravel fill width following Table 14.1-1 for the entire arc length based on the radius of the curve on plan view.
- 3** For outside corners, increase the thickness of the gravel fill width following Table 14.1-2 measured in each direction perpendicularly from the back of the wall face.
- 4** Corner units may be available to facilitate the construction of outside corners.

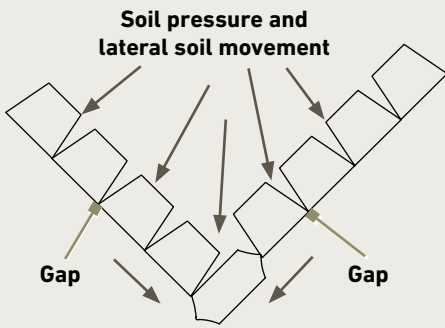

Figure 14.1 | Wall Corner

14.1 GENERAL

Segmental retaining wall structures are by their very nature flexible systems that can accommodate a moderate amount of movement. However, when outside corners and tight curves are incorporated into an otherwise two dimensional system, a third direction of movement can occur that can result in unit cracking or gapping between units.

The stresses and resulting movement illustrated in Figures 14.1, 14.2, and 14.3 usually occur in taller walls with lesser quality backfill, tight radii, and/or poor compaction. The wall backfill strains and deforms laterally under increasing earth pressure resulting in outward movement of the facing and cracking in the bottom third of the wall. This is typically not a noticeable problem in straight walls, but at corners

and bends the movement is magnified and can create the gapping and cracking due to the buildup of radial tensile forces along the wall face.

Where outside corners or radii are incorporated into a project, increase the gravel fill behind the SRW units using a high quality granular backfill as shown on Figure 14 with the width provided on Table 14.1-1 for curves and 14.1-2 for corners. This is particularly important for taller walls as the use of higher quality backfill reduces the amount of outward movement needed to develop the soil’s strength as shown in Figure 14.4 and reduces the amount of compaction energy needed to densify the soil. Both of these factors reduce the outward movement of the corner or radius, minimizing but not eliminating the potential for gaps and cracks.

Table 14.1-1 | Convex Radial Turns – Gravel Fill Width and Minimum Recommended Radius

Based Upon Radius (R) for Curves	Min. Recommended Gravel Width	Placement
$R \geq 2.5H$	Follow Table 1.3-2	Entire Arc Length
$1.5H < R < 2.5H$	H/4	Entire Arc Length
$0.5H < R \leq 1.5H$	H/2	Entire Arc Length
$R \leq 0.5H$	H but not > L	Entire Arc Length

Table 14.1-2 | Convex Corners – Recommended Gravel Fill Width

Based Upon Angle Between Straight Wall Segments (Δ)	Min. Recommended Gravel Width	Placement
150° or Greater	Follow Table 1.3-2	Same as Gravel Width
150° to 115°	H/4	Same as Gravel Width
115° to 75°	H/2	Same as Gravel Width
Less Than 75°	H but not > L	Same as Gravel Width

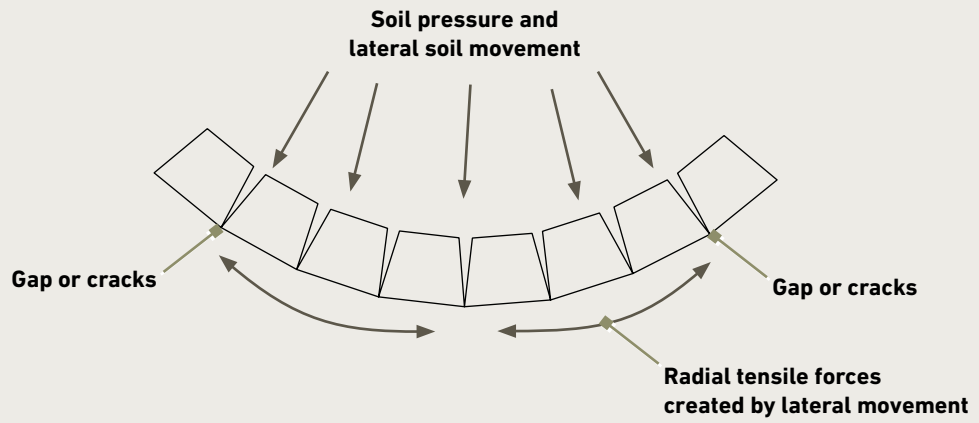

Figure 14.2 | Wall Radius

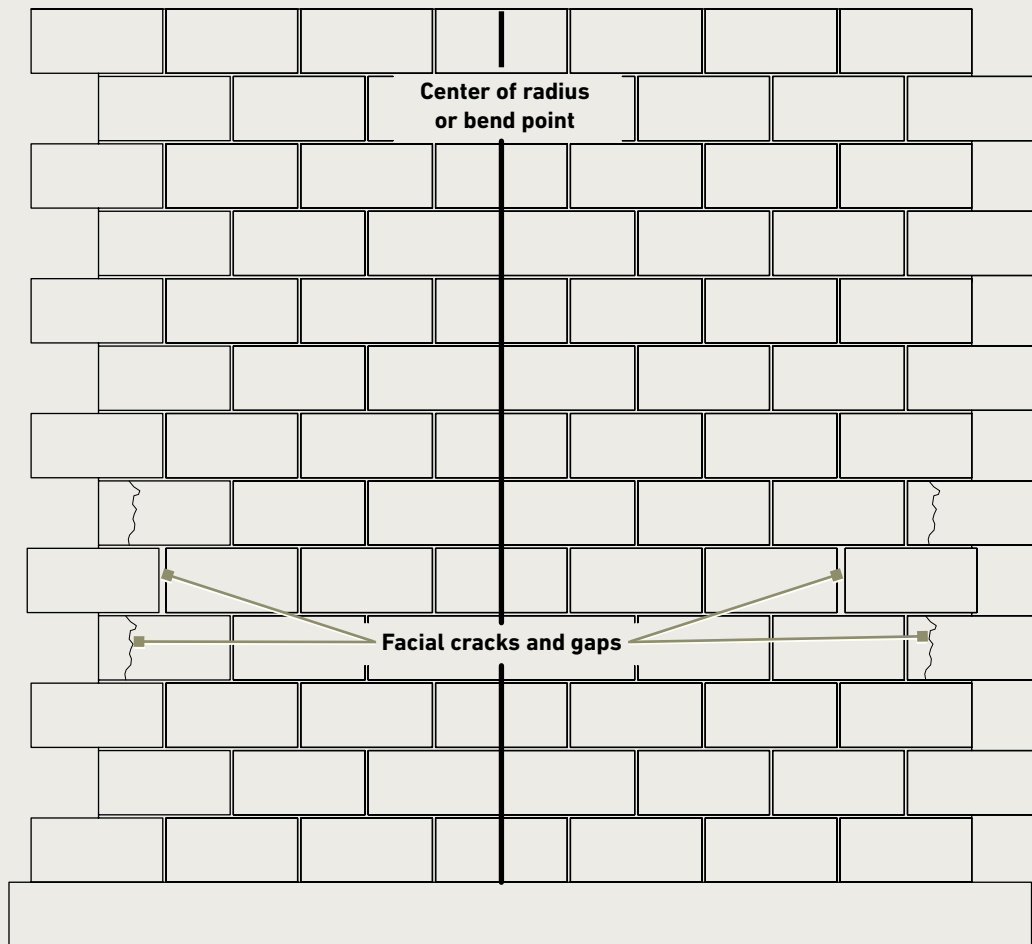

Figure 14.3 | Wall Elevation

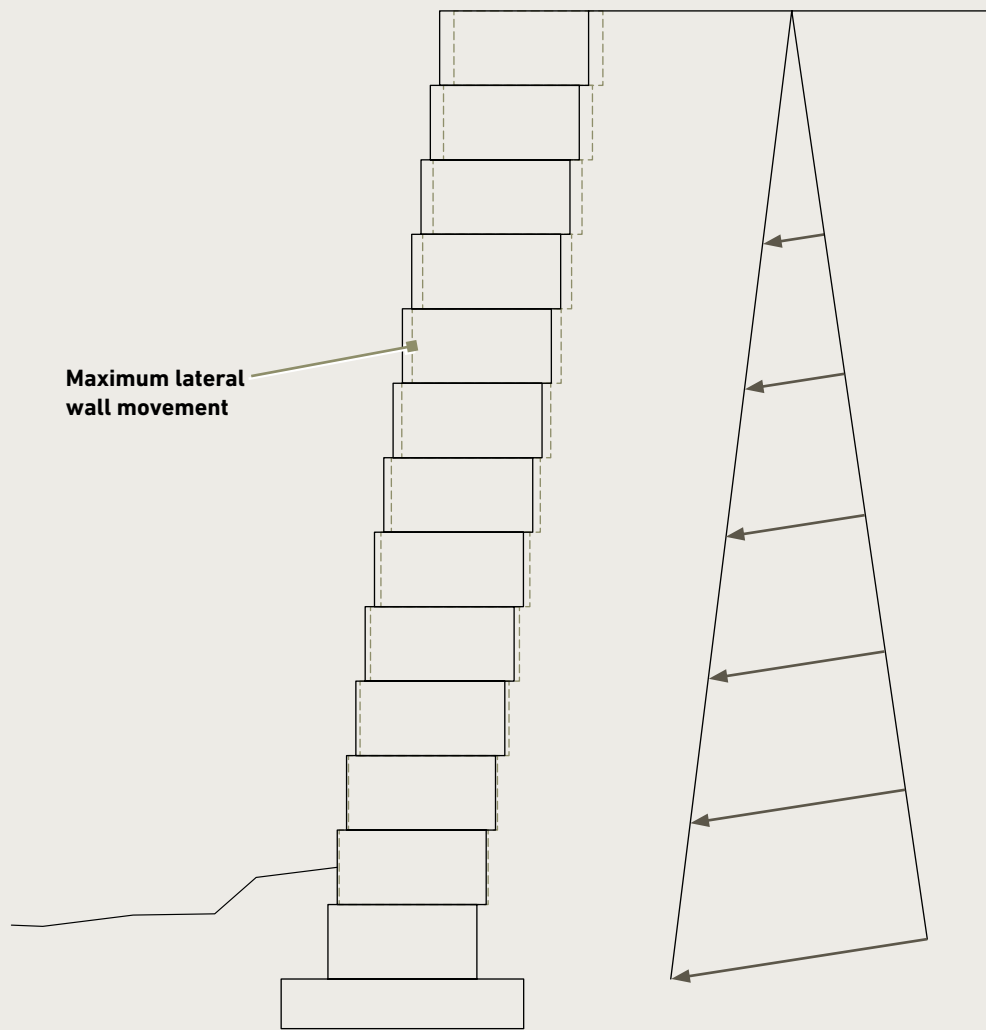

Figure 14.4 | Wall Section

15.1 PRECONSTRUCTION CHECKLIST

Refer to the Design Checklist (Section 15.2) and the Construction and Inspection Checklist (Section 15.3) for topics to review, coordinate, and discuss during the preconstruction meeting.

15.2 DESIGN CHECKLIST

To ensure that the basic industry recommendations are addressed during the design phase of an SRW project, the following checklist should be reviewed by all parties.

1. Site Planning

- Are contour lines clearly shown on the construction drawings and do contour lines close?
- Water management
 - Have potential surface water source(s) been identified?
 - Is site drainage adjacent to the walls accounted for?
 - Does surface water drain away from wall face (except for water applications)?
 - For water applications, is toe erosion protection provided?
 - For water applications, are normal and high water levels identified?
- Have the location of utilities (storm sewer, irrigation, water lines, etc.) been identified and accounted for?
- Are catch basins, utilities and similar structures in the vicinity of the retaining walls clearly shown?
- Are the locations where handrails or fences required shown on the plans?
- Does the SRW, including the reinforced zone, necessary cuts, and non-disturb buffers, fit within the project boundaries?
- Have access routes and storage areas been identified?

2. Geotechnical Report

- Does the geotechnical evaluation include the area where the retaining walls are located?
- Have effective soil stress parameters been determined for:
 - The foundation soils
 - The reinforced zone soils
 - The retained soil zone (general fill)
- Have the foundation soils been evaluated for bearing and settlement for the expected loads from the retaining walls?
- Have locations of expected high ground water been identified?
- Have seismic accelerations been provided, as applicable?
- Has global stability been evaluated?

3. SRW Design Plans

- Have Quality Assurance provisions been defined?
- Have required soil parameters been determined and accounted for?
 - Retained soil friction angle
 - Reinforced soil friction angle
 - Foundation soil friction angle
 - Cohesion for foundation soil
- Are the retaining wall plan layout, elevations, and station points clearly shown on the plans?
- Is the required information conveyed in typical cross-sections?
 - Geogrid strength, length, and elevation shown by station
 - Embedment shown by station
 - Applied bearing pressure provided by station
 - Utilities, if any, shown
 - Drainage details, including toe drain and possible heel drain
 - Top of wall detailing, including swales, fences, guiderails, etc. as applicable

- Have construction notes and specifications been provided and reviewed?
- Have all design variables been accounted for?
 - Compliance with design requirements (NCMA or other) as well as any governing regulations or local ordinances.
 - Design loads, including:
 - Surcharge loads, including magnitudes and locations
 - Loads from handrails, fences, barriers, etc.
 - Temporary or construction loads
 - Snow or storage loads
 - Seismic loads, if applicable
- Internal Compound Stability
- Verify global stability has been evaluated
- Design strengths including sliding, overturning (including top-of-wall), bearing, geogrid overstress, and geogrid pullout (block and soil)
- Water management:
 - Location and venting of toe and heel drains
 - Details for low permeability soils
 - Surface and subsurface water sources accounted for
- Do material submittals comply with project specifications?
- Does the project require any special considerations or construction details?

15.3 CONSTRUCTION AND INSPECTION CHECKLIST

The following Construction and Inspection Checklist provides a list of items covering the basic components of a SRW installation. This checklist may also be used during the bidding process to ensure that all special provisions are

captured and adequately addressed. Always check local building codes that may impact design or construction, document any changes to the construction plans in writing, and notify impacted parties of any concerns.

1. Construction Safety

- Have excavation safety requirements been defined?
- Is fall protection required, and if so, has it been defined?
- Have PPE and dust control (specifically during SRW cutting) requirements been identified?

2. Plans Review

- Does the site plan and wall layout coincide with current site conditions?
- Have all slopes above and below the walls been taken into account on the plans?
- Do the section drawings match the topography of the jobsite?
- Have site utilities been accounted for and shown on the plans?
- Have quality assurance and inspection requirements been defined?
- Are there any recommendations for changes to the plans to accommodate site conditions?

3. Materials

- Soils
 - Verify that the proposed soils (foundation, reinforced, and retained) are consistent with design plan requirements for type, gradation, plasticity, shear strength, etc.
 - Does the site show indications of multiple layers of soil, and if so, has this been accounted for in design?
 - Is there evidence of landfill(s) on the project site?

- Verify that correct Proctor curves are available for soils to be compacted.
- Verify that the gravel fill is clean, compactable, and free-draining in accordance with the project specification.
- Verify that the geotextile material has a current NTPEP evaluation report and is compliance with project specifications.
- Verify the drain pipe is of the correct size and meets project specifications.
- Verify that the geogrid materials and types noted on the design plans are available onsite and have a current NTPEP evaluation report. No substitutions are permitted without prior written approval.
- Verify the correct SRW unit type/configuration having the specified properties, finish, and color are onsite.

4. Quality Control/Quality Assurance

- Wall contractor is responsible for quality control of wall installation per the approved plans. The owner or owner's representative is responsible for engineering and quality assurance of the project.
- Verify that the owner has contracted with an inspection firm responsible for field testing and inspection.
- Identify what method will be used to verify construction materials, methods, and sequence of construction. Options include written documentation of as-built, full time inspector on site, photographic documentation, etc.

5. Site Grading and Foundation Conditions

- Verify that adequate survey staking is in place to establish proper wall alignment, steps, and footing elevations.
- Verify that the existing topography along the retaining wall alignment is consistent with site grading plans used to establish the base of wall location and required embedment. Any major deviations will require reanalysis of the wall design and layout.
- Verify that the limits of excavation are sufficient for the designed reinforcement lengths.
- Verify that groundwater conditions are as expected and any drainage conditions such as seepage or springs are addressed prior to wall construction.
- Verify that the foundation soils are acceptable after any corrections are made to improve bearing as determined by the geotechnical engineer. Note that the wall foundation is the entire width of the leveling pad and reinforced zone and must be competent for the loads imposed.
- Verify Retained Soils are as expected.

6. Drainage

- Verify that toe and heel drains are installed per plans and protected from blockage and damage.
- Verify that the drain outlets either daylight or connect to a underground storm water system and are not blocked.
- Verify that daily grading prevents water from collecting near or cascading over wall face at the top or collecting or running along wall face at the toe causing erosion problems.
- Verify final top and toe slopes meet project plans.

7. Leveling Pad

- ❑ Verify elevations of leveling pad at appropriate stations along wall face.
- ❑ Verify proper embedment based on design plans and existing topography.
- ❑ Verify that the leveling pad dimensions comply with project plans, but not less than 6 inches (152 mm) thick and 12 inches (305 mm) wider than face unit depth.
- ❑ Verify the material used to construct the leveling pad complies with the project specifications.

8. SRW Unit Placement

- ❑ Verify SRW units are placed and filled with gravel fill (when appropriate) one course at a time.
- ❑ Verify that base units are level front to back and side to side.
- ❑ If applicable, verify that pin or connector placement is correct for desired wall batter.
- ❑ Verify that the correct alignment and offset is being maintained by checking actual batter and alignment against reference points.
- ❑ Verify that units are level from front to back at geogrid layers, shimming above or below, but not on the geogrid course. Shims should be continuous and compressible.

9. Gravel Fill Placement

- ❑ Verify that approved gravel fill is placed within, between, and to a minimum of 24 inches from the face of the SRW units or as shown on the plans.

10. Backfill Placement

- ❑ Verify that backfill moisture content when compacted is

within acceptable range.

- ❑ Verify that backfill is placed and compacted slightly higher than the back of SRW unit prior to geogrid placement (no dips and never lower than the top of unit.), or in the case of SRW with trailing lips, to a height to permit the installation of subsequent courses.
- ❑ Verify that backfill is carefully placed to avoid wrinkling or causing slack in reinforcement. Placement and compaction should always run parallel to the wall face.
- ❑ Verify that the fill in front of wall is placed and compacted as soon as practical.

11. Compaction and Testing

- ❑ Verify that compaction testing will be performed, person(s) responsible for performing the testing, locations along the length of the wall testing will be performed, and what coordination will be required.
- ❑ Verify that only light compaction equipment is used within 3 feet (1 m) of the SRW wall face. Thinner lifts may be necessary to achieve the desired compaction.
- ❑ Verify compacted lifts do not exceed 8 inch (203 mm), or as specified in the project plans.

12. Reinforcement Placement

- ❑ Verify that the compacted backfill is at or slightly higher than the back of SRW unit prior to geogrid placement (no dips), or in the case of SRW with trailing lips, to a height to permit the installation of subsequent courses.
- ❑ Verify that the geogrid is the proper type and length for the wall station and elevation.

- ❑ Verify that the geogrid is placed to within 1 inch (25 mm) of the wall face, extended perpendicular to wall face, and pulled taught prior to fill placement.

13. Finish Grading

- ❑ Verify that the finish grade above and below the walls, including slope where applicable, is in accordance with the project plans.

15.4 POST-CONSTRUCTION INSPECTIONS

Upon completion of the SRW construction, a post-construction inspection should be performed to ensure the final work product is in conformance with the project plans and specifications. The initial post construction inspection should be performed with the owner, geotechnical engineer, quality assurance firm, SRW design engineer, SRW installer, and any other interested parties. Key topics to verify and consider include:

- ❑ Evaluate adherence to the construction drawings, plans, and specifications.
- ❑ Review inspection logs and quality control/quality assurance reports.
- ❑ Identify any items requiring correction.
- ❑ Discuss long-term maintenance needs with the owner.

For tall walls and for critical structures, annual or bi-annual inspections of the wall may be warranted, and if conducted, should be performed by a qualified firm. Similar inspections should also be performed following extreme events such as major earthquakes or storms. Any recommendations requiring remediation should be identified and discussed with the owner.

c = cohesion of soil

D = horizontal offset between tiered walls

H = total height of wall

H' = exposed height of wall

H_1 = exposed height of the lower wall

H_2 = exposed height of the upper wall

H_{emb} = embedment depth

H_{ext} = height of back of reinforced wall over which the active earth pressure for external stability is calculated

H_{TOT} = tiered walls total height (from the bottom of the lowest block wall to the top of the last block on the upper most tier)

ICS = internal compound stability

L = length of reinforcement

LL = liquid limit

L_{ref} = reference length

LRFD = load and resistance factor design

LTDS = long term design strength

NTPEP = National Transportation Product Evaluation Program

PET = polyester

PI = plasticity index

1. *Design Manual for Segmental Retaining Walls*, 3rd Edition, Publication No. TR 127B, National Concrete Masonry Association, Herndon, VA, 2010.
2. *2015 International Building Code*, International Code Council, Washington DC, 2014.
3. TEK 15-3A, *Roles and Responsibilities on Segmental Retaining Walls Projects*, National Concrete Masonry Association, Herndon, VA, 2010.
4. *AASHTO LRFD Bridge Design Specification*, 6th edition, American Association of State Highway and Transportation Officials, Washington, D.C. 2012.
5. *Geosynthetic Reinforced Soil Integrated Bridge System, Interim Implementation Guide*, Publication No. FHWA-HRT-11-026, Federal Highway Administration, Washington DC, January 2011.
6. ASTM C1372, *Standard Specification for Dry-Cast Segmental Retaining Wall Units*, ASTM International, West Conshohocken, PA, 2014a.
7. ASTM C1262, *Standard Test Method for Evaluating the Freeze-Thaw Durability of Dry-Cast Segmental Retaining Wall Units and Related Concrete Units*, ASTM International, West Conshohocken, PA, 2010.
8. *Corrosion/Degradation of Soil Reinforcements for Mechanically Stabilized Earth Walls and Reinforced Soil Slopes*, Publication No. FHWA-NHI-09-087, Federal Highway Administration, Washington DC, November, 2009.
9. ASTM F405, *Standard Specification for Corrugated Polyethylene (PE) Pipe and Fittings*, ASTM International, West Conshohocken, PA, 2013.
10. ASTM F758, *Standard Specification for Smooth-Wall Poly(Vinyl Chloride) (PVC) Plastic Underdrain Systems for Highway, Airport, and Similar Drainage*, ASTM International, West Conshohocken, PA, 2014.
11. *SRW Research*, SRW History Article Series, National Concrete Masonry Association, Herndon, VA, 2013.
12. *Durability of Segmental Retaining Wall Blocks: Final Report*, Publication No. FHWA HRT-07-021, Federal Highway Administration, Washington DC, November, 2007.
13. TEK 8-3A, *Control and Removal of Efflorescence*, National Concrete Masonry Association, Herndon, VA, 2003.
14. TEK 18-11B, *Inspection Guide for Segmental Retaining Walls*, National Concrete Masonry Association, Herndon, VA, 2012.
15. *Assessment, Maintenance, and Repair of SRWs*, National Concrete Masonry Association, Herndon, VA, 2015.
16. TEK 15-9B, *Seismic Design of Segmental Retaining Walls*, National Concrete Masonry Association, Herndon, VA, 2015.
17. *Segmental Retaining Wall Installation Guide*, National Concrete Masonry Association, Herndon, VA, 2010.
18. AASHTO M288, *Standard Specifications for Transportation Materials and Methods of Sampling and Testing*, American Association of State Highway and Transportation Officials, Washington, DC, 2006.
19. ASTM D698, *Standard Test Methods for Laboratory Compaction Characteristics of Soils Using Standard Effort*, ASTM International, West Conshohocken, PA, 2012.
20. ASTM D1557, *Standard Test Methods for Laboratory Compaction Characteristics of Soils Using Modified Effort*, ASTM International, West Conshohocken, PA, 2012.

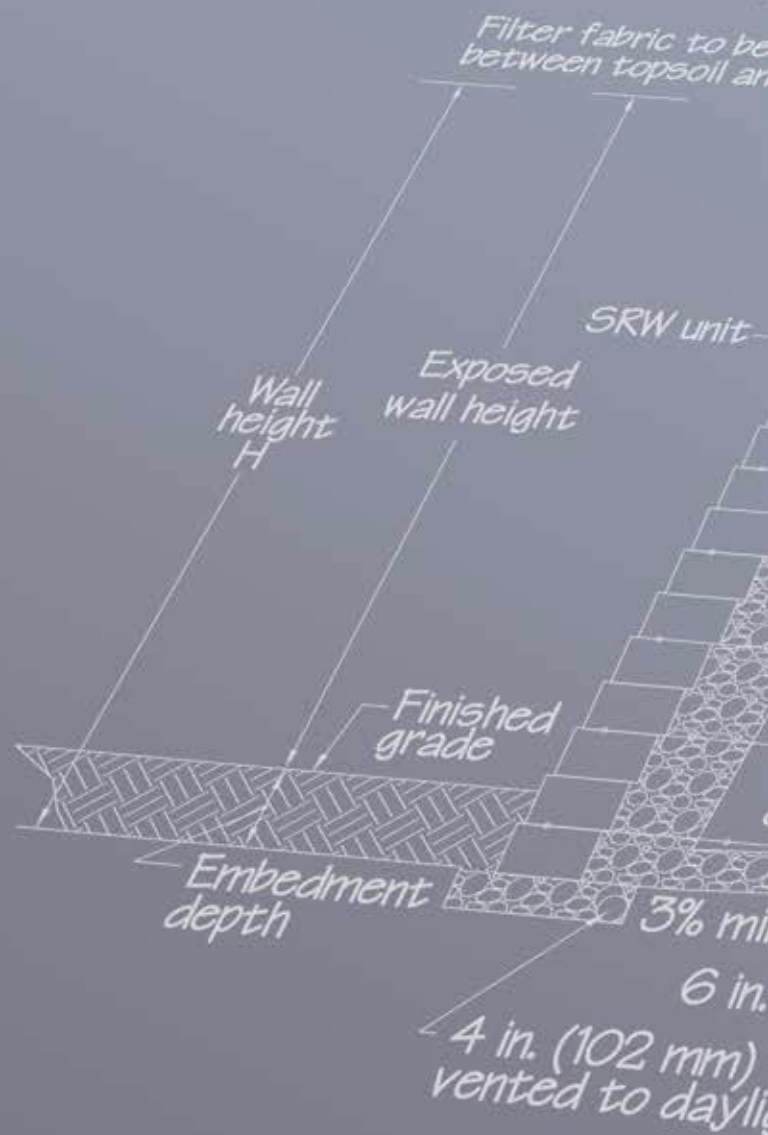

National Concrete Masonry Association

13750 Sunrise Valley Drive | Herndon, VA 20171 | www.ncma.org

NCMA Publication Number: TR308 | Edition: 1 | Printing: 2 - Last Revised September 7, 2017